

# **DuraBlue® II Adhesive Melters Models 20 and 45**

Customer Product Manual

Part 1126931\_01

Issued 08/18



This document contains important safety information.  
Be sure to read and follow all safety information in this  
document and any other related documentation.



Nordson Corporation welcomes requests for information, comments, and inquiries about its products. General information about Nordson can be found on the Internet using the following address: <http://www.nordson.com>.

Address all correspondence to:

Nordson Corporation  
Attn: Customer Service  
11475 Lakefield Drive  
Duluth, GA 30097

#### Notice

This is a Nordson Corporation publication which is protected by copyright. Original copyright date 2018. No part of this document may be photocopied, reproduced, or translated to another language without the prior written consent of Nordson Corporation. The information contained in this publication is subject to change without notice.

#### Trademarks

Allegro, Apogee, Artiste, Asymtek, Automove, Avex, BaitGun, BKG, Blue Box, BM-32, BM-58, BM-63, Bowtie, Build-A-Part, CF, Century, CleanSleeve, CleanSpray, Color-on-Demand, ColorMax, Conexis, Connections to Life, Contour, Control Coat, Coolwave, Cross-Cut, CrystallCut, Dage, Dima, DispenseJet, DispenseMate, DuraBlue, DuraDrum, DuraPail, e.dot, e-stylized, Easymelt, Ecodry, Econo-Coat, EDI, EFD, Eliminator, Encore, Equatherm, Excel 2000, Fibrijet, Fluidmove, FoamMelt, FoamMelt - stylized, FoamMix, Freedom, Fulfill, HDLV, Heli-flow, iControl, iDry, iFlow, IntelliJet, Isocore, Iso-Flo, iTrax, KISS, Lean Cell, LogiComm, March, Matrix, MatriX, Maverick, Measuring the Invisible, MEG, Meltex, MicroCoat, MicroMark, Micromedics, Micro-Meter, Microshot, Millennium, MiniBlue, Mini Squirt, NexJet, No-Drip, Nordson, Nordson - stylized, Nordson and Arc, OptiMix, Optima, Optimum, Package of Values, Paragon, PermaFlo, PICO, Plasmod, Poly-Check, Polymer Solution Casting, Porous Coat, Posi-Dose, PowderGrid, Precisecoat, PrintPlus, ProBlue, ProBlue Liberty, Prodigy, Pro-Flo, Program-A-Bead, Program-A-Shot, Program-A-Stream, Program-A-Swirl, Pro-Meter, Pulsar, Quantum, Ratio-Pak, RBX, RediSet, Rhino, Saturn, Saturn with Rings, Scoreguard, Sealant Equipment & Engineering, Inc., SEE (and design), See-Flo, Select Charge, Select Coat, Select Cure, Servo-Flo, Shot-A-Matic, Signature - stylized, Slaughterback, Smart-Coat, Smart-Gun, SolderPlus, Spectrum, Speed-Coat, StediFlo, Stratablend, SureBead, Sure Coat, SureWrap, Tip-Seal, TRAK, Tribomatic, Trilogy, TrueBlue, TrueCoat, Turbo, Ultra, u-TAH, Value Plastics, Vantage, Vention Medical, Vention Medical Advancing Your Innovations For Health, VersaBlue, Versa-Coat, VersaDrum, VersaPail, Versa-Spray, VP stylized, When you expect more., X-Plane, Xaloy, Xaloy - stylized, YesTech, and 2 Rings (design) are registered trademarks of Nordson Corporation.

Accubar, Active Nozzle, Advanced Plasma Systems, AeroDeck, AeroWash, AirShield, AltaBlue, AltaSlot, Alta Spray, ATS, Auto-Flo, Autoflex, AutoScan, Axiom, Best Choice, Better Dispensing, Blue Series, Bravura, CanPro, Champion, Check Mate, Classic IX, ClassicBlue, Clean Coat, Cobalt, Concert, ContourCoat, Control Weave, Controlled Fiberization, CPX, cScan+, cSelect, Cyclo-Kinetic, Dial-A-Dose, DispensLink, Dry Cure, DuraBraid, DuraCoat, DuraPUR, e.dot+, Emerald, E-Nordson, Easy Clean, EasyOn, EasyPW, Eclipse, EcoBead, EdgeControl, Equalizer, Equi=Bead, FillEasy, Fill Sentry, FlexSeam, Flow Coat, FluxPlus, G-Net, G-Site, Genius, Get Green With Blue, Horizon, Inspire, iON, Iso-Flex, iTrend, Lacquer Cure, LightTite, Maxima, Mesa, MicroFin, MicroMax, Mikros, MiniEdge, Minimater, MiniPUR, Multifill, MultiScan, Myritex, Nano, OmniScan, OptiStroke, Optix, Partnership+Plus, PatternJet, PCI, PharmaLok, PicoDot, Pinnacle, Powder Pilot, Powder Port, Powercure, Process Sentry, Pulse Spray, PURBlue, PUReOne, PURJet, Qadence, Ready Coat, RediCoat, RollVIA, Royal Blue, Select Series, Sensomatic, Shaftshield, SheetAire, Smart, Smartfil, SolidBlue, Spectral, SpeedKing, Spray Works, StediTherm, StrokeControl, Summit, SureFoam, Sure Mix, SureSeal, Swirl Coat, TAH, Trade Plus, ThruCoat, ThruCure, ThruWave, Trio, TruFlow, Ultraflex, Ultrasaver, Ultrasmart, Unity, UNITYMotion, Universal, Ultra FoamMix, UltraMax, ValueMate, Versa, VersaPUR, Vista, VP Quick Fit, VP Quick-Fit stylized, Web Cure, 781Mini, and 787Mini are trademarks of Nordson Corporation.

Designations and trademarks stated in this document may be brands that, when used by third parties for their own purposes, could lead to violation of the owners' rights.

# Table of Contents

<b>Safety</b> .....	<b>1-1</b>
Safety Alert Symbols .....	1-1
Responsibilities of the Equipment Owner .....	1-2
Safety Information .....	1-2
Instructions, Requirements, and Standards .....	1-2
User Qualifications .....	1-3
Applicable Industry Safety Practices .....	1-3
Intended Use of the Equipment .....	1-3
Instructions and Safety Messages .....	1-4
Installation Practices .....	1-4
Operating Practices .....	1-4
Maintenance and Repair Practices .....	1-5
Equipment Safety Information .....	1-5
Equipment Shutdown .....	1-6
Relieving System Hydraulic Pressure .....	1-6
De-energizing the System .....	1-6
Disabling the Applicators .....	1-6
General Safety Warnings and Cautions .....	1-7
Other Safety Precautions .....	1-10
First Aid .....	1-10
Safety Labels and Tags .....	1-11
<b>Introduction</b> .....	<b>2-1</b>
Intended Use .....	2-1
Electromagnetic Compatibility (EMC) .....	2-1
Examples of Unintended Use .....	2-2
Residual Risks .....	2-2
Key Components .....	2-3
Electrical Components .....	2-4
Control Panel .....	2-5
Tank Isolation Valve .....	2-6
Pressure Control Valves .....	2-6
Modes of Operation .....	2-7
Automatic Scan (Normal Mode) .....	2-7
Standby .....	2-7
Setup .....	2-7
Fault .....	2-7
Gear-to-Line Capability .....	2-7
Melter Identification .....	2-8

<b>Installation</b> .....	<b>3-1</b>
Overview .....	3-1
Additional Information .....	3-1
Installation Tasks .....	3-2
Experience of Installation Personnel .....	3-2
Installation Requirements .....	3-2
Clearances .....	3-2
Ventilation .....	3-4
Electrical Power .....	3-4
Other Considerations .....	3-5
Unpacking the Melter .....	3-6
Moving the Unpacked Melter .....	3-6
Contents of the Installation Kit .....	3-6
Customer-Supplied Materials .....	3-6
Configuring the Electrical Service .....	3-7
Residual Current Circuit Breakers .....	3-7
Connecting the Electrical Service .....	3-7
Connecting Hoses and Applicators .....	3-9
Connect Hoses .....	3-9
Connect Applicators .....	3-12
Setting Up the Melter .....	3-13
Quick Setup .....	3-13
Operating Parameters .....	3-15
Selecting Operating Parameters .....	3-15
Reading or Editing Operating Parameters .....	3-16
Set-point Temperature of the Tank, Hoses, and Applicators .....	3-20
Save and Restore Melter Settings .....	3-22
Review Parameter and Set-point Temperature Changes .....	3-23
Setting Up Inputs/Outputs .....	3-25
Wire Inputs/Outputs to the Melter .....	3-26
Set Up Inputs/Outputs .....	3-27
Setting Up Gear-to-Line Operation .....	3-31
Setting Up Motor Run Status Monitoring .....	3-32
Wiring .....	3-32
Keypad Buttons .....	3-32
Programming .....	3-33
Installing Optional Equipment .....	3-34
Connecting an Applicator Driver, Pattern Controller, or Timer .....	3-34
Flushing the Melter .....	3-34
Disposing of Melter .....	3-34
<b>Operation</b> .....	<b>4-1</b>
Additional Information .....	4-1
Filling the Tank .....	4-2
About Heated Components .....	4-2
Starting the Melter .....	4-3
Manually Adjusting the Pump Speed .....	4-6
Adjust the Motor Speed for Manual Operation .....	4-6
Adjusting Material Pressure .....	4-7
Monitoring the Melter .....	4-8
Confirm that the Melter is Operating Correctly .....	4-8
Monitor Component Temperatures .....	4-9
Monitor Melter Faults .....	4-11
Monitor the Service Interval .....	4-17

Adjusting Component Temperatures .....	4-18
Entering a Password .....	4-22
Using Function Keys .....	4-23
Heater Key .....	4-23
Master Pump Enable Key .....	4-23
Setup Key .....	4-24
Seven-Day Clock Key .....	4-24
Standby Key .....	4-25
Shutting Down the Melter .....	4-26
Record of Melter Settings .....	4-27
<b>Service .....</b>	<b>5-1</b>
Relieving System Pressure .....	5-1
Through the Applicators .....	5-1
Through the Melter Drain Valves .....	5-2
Preventive Maintenance Schedule .....	5-3
Changing the Material Type .....	5-4
Detaching the Exterior Panels .....	5-4
Fan and Air Filter .....	5-4
Motor and Gear Box .....	5-5
Changing the Motor Lubricant .....	5-5
Replacing a Motor or Coupling .....	5-6
Pump .....	5-8
Tightening the Pump Screws .....	5-8
Replacing a Pump .....	5-9
Replacing the Adhesive Filter .....	5-13
Replace the Adhesive Filter .....	5-14
Pressure Control Valve .....	5-15
Replace the Pressure Control Valve .....	5-15
Pressure/Circulation Control Valve Service Kit .....	5-16
Cleaning the Tank .....	5-17
Draining Material from the Tank .....	5-17
Cleaning the Tank by Hand .....	5-17
Tightening the Fixing Screws .....	5-17
Main PCA Board .....	5-18
Replace the Main PCA Board .....	5-18
Maintenance Record Form .....	5-21
<b>Troubleshooting .....</b>	<b>6-1</b>
Safety .....	6-1
Troubleshooting Quick-Checks .....	6-2
Returning the Melter Setup to Factory Settings .....	6-2
Melter Faults .....	6-3
Motor Control Faults .....	6-5
Changing a Motor Control Parameter .....	6-6
Motor Drive Faults .....	6-8
LED Status Display .....	6-9
Motor Drive Error History .....	6-10
Error History .....	6-10
Error Messages .....	6-12

Changing a Motor Drive Parameter .....	6-15
Keypad .....	6-15
Display .....	6-15
Favorites Group Navigation .....	6-17
Saving the Settings .....	6-18
Navigation Group 1-7 .....	6-19
Saving the Settings .....	6-19
Motor Drive Parameter Factory Settings .....	6-20
Calibrating the Pump Speed Display .....	6-21
Troubleshooting Tables .....	6-22
Melter Not Functioning .....	6-22
One Channel (Heating Zone) Does Not Heat .....	6-22
Control Panel Does Not Function .....	6-22
No Material (Motor Does not Rotate) .....	6-23
No Material (Motor Rotating) .....	6-24
Too Little Material .....	6-24
Material Pressure Too High .....	6-25
Material Pressure Too Low .....	6-25
Material Residue in Tank .....	6-26
Material Hardens in Tank .....	6-26
Others .....	6-26
<b>Parts .....</b>	<b>7-1</b>
Using the Illustrated Parts List .....	7-1
Melter Part Numbers .....	7-2
Frame Assembly .....	7-3
Melter Frame Parts .....	7-3
Manifold Assembly .....	7-4
1-Single Stream Manifold Assembly .....	7-4
Hopper Assembly .....	7-6
Melter Hopper Parts .....	7-6
Pump Assemblies .....	7-8
Drive Module Parts .....	7-8
Single-Stream Gear Pumps .....	7-9
Safety Valve Parts .....	7-10
Control Valve Assemblies .....	7-11
Control Valve Module Parts .....	7-11
Filter Cartridge Parts .....	7-12
Pressure Control Valve Parts .....	7-13
Motor Assembly .....	7-14
Electrical Enclosure Panel Assemblies .....	7-16
Melter Left Panel Parts - 400V .....	7-16
.....	7-16
Melter Back Panel Parts - 400V .....	7-18
Melter Right Panel Parts - 400V .....	7-20
Control Panel Assembly .....	7-24
Sensor Assembly .....	7-25
Optional Fittings .....	7-26
Recommended Spare Parts .....	7-27

---

<b>Technical Data</b> .....	<b>8-1</b>
General Data .....	8-1
Temperatures .....	8-1
Electrical Data .....	8-2
Mechanical Data .....	8-2
Electrical Schematics .....	8-3
Hydraulic Schematic .....	8-4
<b>Calculating Melter Power Requirements</b> .....	<b>A-1</b>
Evaluate Hose/Applicator Power Requirements .....	A-2
<b>Operating Parameters</b> .....	<b>B-1</b>
Standard .....	B-2
Input Setup .....	B-9
Output Setup .....	B-12
Seven-day Clock .....	B-13
PID Selection .....	B-19
<b>Melter Communications</b> .....	<b>C-1</b>
Software Availability .....	C-1
System Requirements .....	C-1
Installing the Software .....	C-2
Removing the Software from Your PC .....	C-4
Connecting the PC and the Melter .....	C-5
Using Nordson Configuration Manager .....	C-6
Saving and Restoring Melter Settings .....	C-6
Upgrading or Restoring Melter Firmware .....	C-7
Troubleshooting .....	C-10
Using Nordson Configuration Manager .....	C-10

This page intentionally left blank.



# Section 1

## Safety

Read this section before using the equipment. This section contains recommendations and practices applicable to the safe installation, operation, and maintenance (hereafter referred to as “use”) of the product described in this document (hereafter referred to as “equipment”). Additional safety information, in the form of task-specific safety alert messages, appears as appropriate throughout this document.



**WARNING!** Failure to follow the safety messages, recommendations, and hazard avoidance procedures provided in this document can result in personal injury, including death, or damage to equipment or property.

## *Safety Alert Symbols*

The following safety alert symbol and signal words are used throughout this document to alert the reader to personal safety hazards or to identify conditions that may result in damage to equipment or property. Comply with all safety information that follows the signal word.



**WARNING!** Indicates a potentially hazardous situation that, if not avoided, can result in serious personal injury, including death.



**CAUTION!** Indicates a potentially hazardous situation that, if not avoided, can result in minor or moderate personal injury.

**CAUTION!** (Used without the safety alert symbol) Indicates a potentially hazardous situation that, if not avoided, can result in damage to equipment or property.

## ***Responsibilities of the Equipment Owner***

Equipment owners are responsible for managing safety information, ensuring that all instructions and regulatory requirements for use of the equipment are met, and for qualifying all potential users.

### **Safety Information**

- Research and evaluate safety information from all applicable sources, including the owner-specific safety policy, best industry practices, governing regulations, material manufacturer's product information, and this document.
- Make safety information available to equipment users in accordance with governing regulations. Contact the authority having jurisdiction for information.
- Maintain safety information, including the safety labels affixed to the equipment, in readable condition.

### **Instructions, Requirements, and Standards**

- Ensure that the equipment is used in accordance with the information provided in this document, governing codes and regulations, and best industry practices.
- If applicable, receive approval from your facility's engineering or safety department, or other similar function within your organization, before installing or operating the equipment for the first time.
- Provide appropriate emergency and first aid equipment.
- Conduct safety inspections to ensure required practices are being followed.
- Re-evaluate safety practices and procedures whenever changes are made to the process or equipment.

## User Qualifications

Equipment owners are responsible for ensuring that users:

- receive safety training appropriate to their job function as directed by governing regulations and best industry practices
- are familiar with the equipment owner's safety and accident prevention policies and procedures
- receive equipment- and task-specific training from another qualified individual

**NOTE:** Nordson can provide equipment-specific installation, operation, and maintenance training. Contact your Nordson representative for information

- possess industry- and trade-specific skills and a level of experience appropriate to their job function
- are physically capable of performing their job function and are not under the influence of any substance that degrades their mental capacity or physical capabilities

## *Applicable Industry Safety Practices*

The following safety practices apply to the use of the equipment in the manner described in this document. The information provided here is not meant to include all possible safety practices, but represents the best safety practices for equipment of similar hazard potential used in similar industries.

## Intended Use of the Equipment

- Use the equipment only for the purposes described and within the limits specified in this document.
- Do not modify the equipment.
- Do not use incompatible materials or unapproved auxiliary devices. Contact your Nordson representative if you have any questions on material compatibility or the use of non-standard auxiliary devices.

## Instructions and Safety Messages

- Read and follow the instructions provided in this document and other referenced documents.
- Familiarize yourself with the location and meaning of the safety warning labels and tags affixed to the equipment. Refer to *Safety Labels and Tags* at the end of this section.
- If you are unsure of how to use the equipment, contact your Nordson representative for assistance.

## Installation Practices

- Install the equipment in accordance with the instructions provided in this document and in the documentation provided with auxiliary devices.
- Ensure that the equipment is rated for the environment in which it will be used. This equipment has not been certified for compliance with the ATEX directive nor as nonincendive and should not be installed in potentially explosive environments.
- Ensure that the processing characteristics of the material will not create a hazardous environment. Refer to the Safety Data Sheet (SDS) for the material.
- If the required installation configuration does not match the installation instructions, contact your Nordson representative for assistance.
- Position the equipment for safe operation. Observe the requirements for clearance between the equipment and other objects.
- Install lockable power disconnects to isolate the equipment and all independently powered auxiliary devices from their power sources.
- Properly ground all equipment. Contact your local building code enforcement agency for specific requirements.
- Ensure that fuses of the correct type and rating are installed in fused equipment.
- Contact the authority having jurisdiction to determine the requirement for installation permits or inspections.

## Operating Practices

- Familiarize yourself with the location and operation of all safety devices and indicators.
- Confirm that the equipment, including all safety devices (guards, interlocks, etc.), is in good working order and that the required environmental conditions exist.
- Use the personal protective equipment (PPE) specified for each task. Refer to *Equipment Safety Information* or the material manufacturer's instructions and SDS for PPE requirements.
- Do not use equipment that is malfunctioning or shows signs of a potential malfunction.

## Maintenance and Repair Practices

- Allow only personnel with appropriate training and experience to operate or service the equipment.
- Perform scheduled maintenance activities at the intervals described in this document.
- Relieve system hydraulic and pneumatic pressure before servicing the equipment.
- De-energize the equipment and all auxiliary devices before servicing the equipment.
- Use only new Nordson-authorized refurbished or replacement parts.
- Read and comply with the manufacturer's instructions and the SDS supplied with equipment cleaning compounds.

**NOTE:** SDSs for cleaning compounds that are sold by Nordson are available at [www.nordson.com](http://www.nordson.com) or by calling your Nordson representative.

- Confirm the correct operation of all safety devices before placing the equipment back into operation.
- Dispose of waste cleaning compounds and residual process materials according to governing regulations. Refer to the applicable SDS or contact the authority having jurisdiction for information.
- Keep equipment safety warning labels clean. Replace worn or damaged labels.

## *Equipment Safety Information*

This equipment safety information is applicable to the following types of Nordson equipment:

- hot melt and cold adhesive application equipment and all related accessories
- pattern controllers, timers, detection and verification systems, and all other optional process control devices

## Equipment Shutdown

To safely complete many of the procedures described in this document, the equipment must first be shut down. The level of shut down required varies by the type of equipment in use and the procedure being completed. If required, shut down instructions are specified at the start of the procedure. The levels of shut down are:

### ***Relieving System Hydraulic Pressure***

Completely relieve system hydraulic pressure before breaking any hydraulic connection or seal. Refer to the melter-specific product manual for instructions on relieving system hydraulic pressure.

### ***De-energizing the System***

Isolate the system (melter, hoses, applicators, and optional devices) from all power sources before accessing any unprotected high-voltage wiring or connection point.

1. Turn off the equipment and all auxiliary devices connected to the equipment (system).
2. To prevent the equipment from being accidentally energized, lock and tag the disconnect switch(es) or circuit breaker(s) that provide input electrical power to the equipment and optional devices.

**NOTE:** Government regulations and industry standards dictate specific requirements for the isolation of hazardous energy sources. Refer to the appropriate regulation or standard.

### ***Disabling the Applicators***

**NOTE:** Adhesive dispensing applicators are referred to as “guns” in some previous publications.

All electrical or mechanical devices that provide an activation signal to the applicators, applicator solenoid valve(s), or the melter pump must be disabled before work can be performed on or around an applicator that is connected to a pressurized system.

1. Turn off or disconnect the applicator triggering device (pattern controller, timer, PLC, etc.).
2. Disconnect the input signal wiring to the applicator solenoid valve(s).
3. Reduce the air pressure to the applicator solenoid valve(s) to zero; then relieve the residual air pressure between the regulator and the applicator.

## General Safety Warnings and Cautions

Table 1-1 contains the general safety warnings and cautions that apply to Nordson hot melt and cold adhesive equipment. Review the table and carefully read all of the warnings or cautions that apply to the type of equipment described in this manual.

Equipment types are designated in Table 1-1 as follows:

**HM** = Hot melt (melters, hoses, applicators, etc.)

**PC** = Process control

**CA** = Cold adhesive (dispensing pumps, pressurized container, and applicators)

Table 1-1 General Safety Warnings and Cautions









Equipment Type	Warning or Caution
HM	 <p><b>WARNING!</b> Hazardous vapors! Before processing any polyurethane reactive (PUR) hot melt or solvent-based material through a compatible Nordson melter, read and comply with the material's SDS. Ensure that the material's processing temperature and flashpoints will not be exceeded and that all requirements for safe handling, ventilation, first aid, and personal protective equipment are met. Failure to comply with SDS requirements can cause personal injury, including death.</p>
HM	 <p><b>WARNING!</b> Reactive material! Never clean any aluminum component or flush Nordson equipment with halogenated hydrocarbon fluids. Nordson melters and applicators contain aluminum components that may react violently with halogenated hydrocarbons. The use of halogenated hydrocarbon compounds in Nordson equipment can cause personal injury, including death.</p>
HM, CA	 <p><b>WARNING!</b> System pressurized! Relieve system hydraulic pressure before breaking any hydraulic connection or seal. Failure to relieve the system hydraulic pressure can result in the uncontrolled release of hot melt or cold adhesive, causing personal injury.</p>
<i>Continued...</i>	

Table 1-1 General Safety Warnings and Cautions (contd)

Equipment Type	Warning or Caution
HM	 <p><b>WARNING!</b> Molten material! Wear eye or face protection, clothing that protects exposed skin, and heat-protective gloves when servicing equipment that contains molten hot melt. Even when solidified, hot melt can still cause burns. Failure to wear appropriate personal protective equipment can result in personal injury.</p>
HM, PC	 <p><b>WARNING!</b> Equipment starts automatically! Remote triggering devices are used to control automatic hot melt applicators. Before working on or near an operating applicator, disable the applicator's triggering device and remove the air supply to the applicator's solenoid valve(s). Failure to disable the applicator's triggering device and remove the supply of air to the solenoid valve(s) can result in personal injury.</p>
HM, CA, PC	 <p><b>WARNING!</b> Risk of electrocution! Even when switched off and electrically isolated at the disconnect switch or circuit breaker, the equipment may still be connected to energized auxiliary devices. De-energize and electrically isolate all auxiliary devices before servicing the equipment. Failure to properly isolate electrical power to auxiliary equipment before servicing the equipment can result in personal injury, including death.</p>
HM, CA, PC	 <p><b>WARNING!</b> Risk of fire or explosion! Nordson adhesive equipment is not rated for use in explosive environments and has not been certified for the ATEX directive or as nonincendive. In addition, this equipment should not be used with solvent-based adhesives that can create an explosive atmosphere when processed. Refer to the SDS for the adhesive to determine its processing characteristics and limitations. The use of incompatible solvent-based adhesives or the improper processing of solvent-based adhesives can result in personal injury, including death.</p>
HM, CA, PC	 <p><b>WARNING!</b> Allow only personnel with appropriate training and experience to operate or service the equipment. The use of untrained or inexperienced personnel to operate or service the equipment can result in injury, including death, to themselves and others and can damage to the equipment.</p>



Equipment Type	Warning or Caution
HM	 <p><b>CAUTION!</b> Hot surfaces! Avoid contact with the hot metal surfaces of applicators, hoses, and certain components of the melter. If contact can not be avoided, wear heat-protective gloves and clothing when working around heated equipment. Failure to avoid contact with hot metal surfaces can result in personal injury.</p>
HM	<p><b>CAUTION!</b> Some Nordson melters are specifically designed to process polyurethane reactive (PUR) hot melt. Attempting to process PUR in equipment not specifically designed for this purpose can damage the equipment and cause premature reaction of the hot melt. If you are unsure of the equipment's ability to process PUR, contact your Nordson representative for assistance.</p>
HM, CA	<p><b>CAUTION!</b> Before using any cleaning or flushing compound on or in the equipment, read and comply with the manufacturer's instructions and the SDS supplied with the compound. Some cleaning compounds can react unpredictably with hot melt or cold adhesive, resulting in damage to the equipment.</p>
HM	<p><b>CAUTION!</b> Nordson hot melt equipment is factory tested with Nordson Type R fluid that contains polyester adipate plasticizer. Certain hot melt materials can react with Type R fluid and form a solid gum that can clog the equipment. Before using the equipment, confirm that the hot melt is compatible with Type R fluid.</p>

## Other Safety Precautions

- Do not use an open flame to heat hot melt system components.
- Check high pressure hoses daily for signs of excessive wear, damage, or leaks.
- Never point a dispensing handgun at yourself or others.
- Suspend dispensing handguns by their proper suspension point.

## First Aid

If molten hot melt comes in contact with your skin:

1. Do NOT attempt to remove the molten hot melt from your skin.
2. Immediately soak the affected area in clean, cold water until the hot melt has cooled.
3. Do NOT attempt to remove the solidified hot melt from your skin.
4. In case of severe burns, treat for shock.
5. Seek expert medical attention immediately. Give the SDS for the hot melt to the medical personnel providing treatment.

# Safety Labels and Tags

Figure 1-1 illustrates the location of the product safety labels and tags affixed to the equipment. Table 1-2 provides an illustration of the hazard identification symbols that appear on each safety label and tag, the meaning of the symbol, or the exact wording of any safety message.

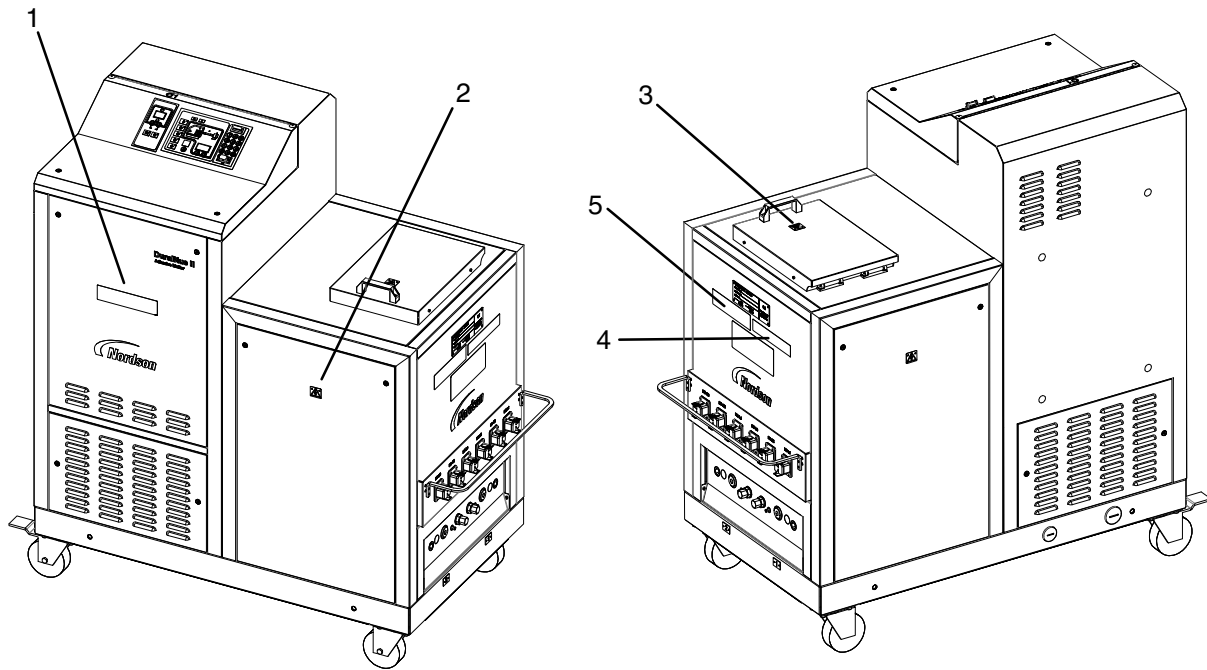
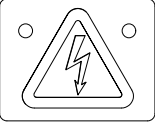
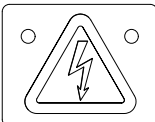



Figure 1-1 Safety labels and tags

Table 1-2 Safety Labels and Tags

Item	Part	Description
1.	1025795	 [Tag, warning, hazardous volts] <b>WARNING:</b> Hazardous voltage. Disconnect all power supply connections before servicing.
2.	224906	 [Tag, warning, electrical shock]
3.	224905	 [Tag, warning, hot]
4.	1025326	[Tag, caution, hot surface]
5.	1021983	[Tag, warning, hot adh/hyd press]



## *Section 2*

# **Introduction**

### ***Intended Use***

DuraBlue® II adhesive melters may be used only to melt and convey suitable materials, e.g. thermoplastic hot melt adhesives.

Any other use is considered to be unintended. Nordson will not be liable for personal injury or property damage resulting from unintended use.

Intended use includes the observance of Nordson safety instructions. Nordson recommends obtaining detailed information on the materials to be used.

### **Electromagnetic Compatibility (EMC)**

In regard to electromagnetic compatibility (EMC), the melter is intended for use in industrial applications.

When operated in residential or commercial areas, the melter may cause interference in other electrical units, e.g. radios.

## Examples of Unintended Use

The melter may not be used under the following conditions:

- In defective condition
- Without insulation blanket and protective panels
- With electrical cabinet door open
- With tank lid open
- In a potentially explosive atmosphere
- When the values stated under *Technical Data* are not complied with.

The melter may not be used to process the following materials:

- Polyurethane hot melt adhesive (PUR)
- Explosive and flammable materials
- Erosive and corrosive materials
- Food products

## Residual Risks

In the design of the unit, every measure was taken to protect personnel from potential danger. However, some residual risks can not be avoided:

- Risk of burns from hot material.
- Risk of burns when filling the tank, from the tank lid, and from the tank lid supports.
- Risk of burns when conducting maintenance and repair work for which the melter must be heated up.
- Risk of burns when attaching and removing heated hoses.
- Material fumes can be hazardous. Avoid inhalation.
- Risk of damage to cables/lines belonging to the customer, if they were installed such that they come into contact with hot or rotating parts.
- The safety valve may malfunction due to hardened or charred material.

# Key Components

Figure 2-1 provides the name and the location of key melter components.

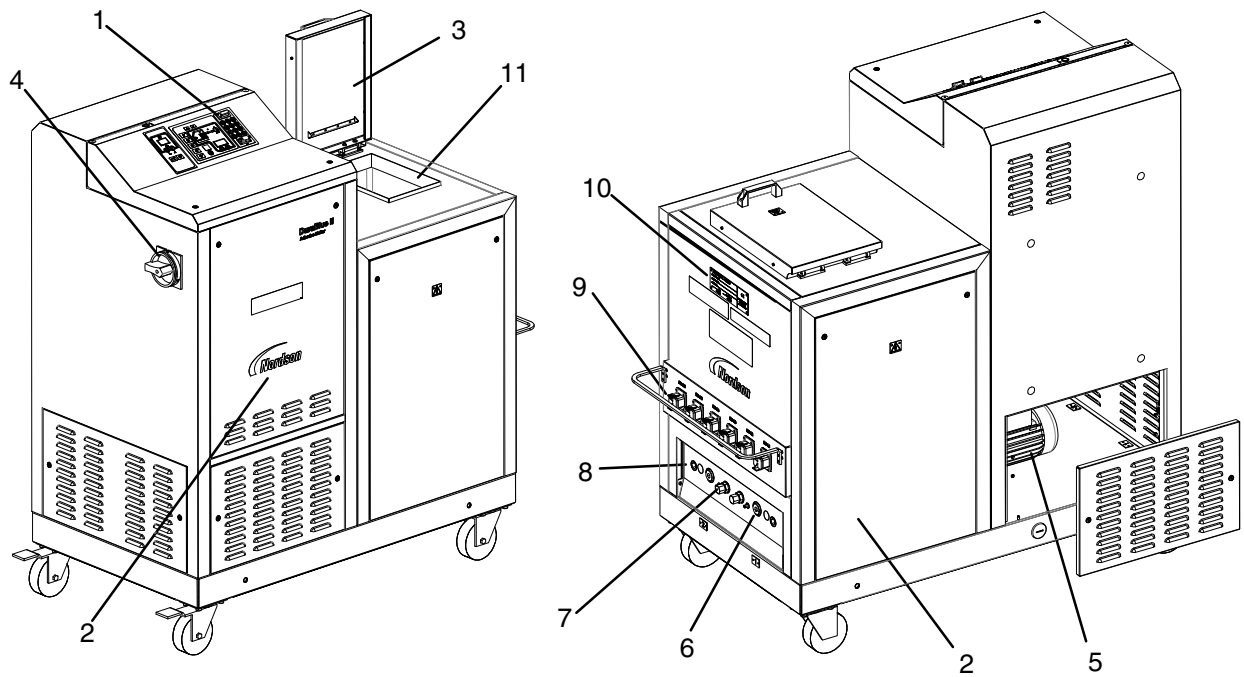

Figure 2-1 Key melter components

- |                                  |                          |                    |
|----------------------------------|--------------------------|--------------------|
| 1 Control panel (see Figure 2-3) | 5 Motors/pumps           | 9 Hose receptacles |
| 2 Protective panel, removable    | 6 Drain valve            | 10 ID plate        |
| 3 Tank lid                       | 7 Pressure control valve | 11 Tank            |
| 4 Main power switch              | 8 Manifold               |                    |

## Electrical Components

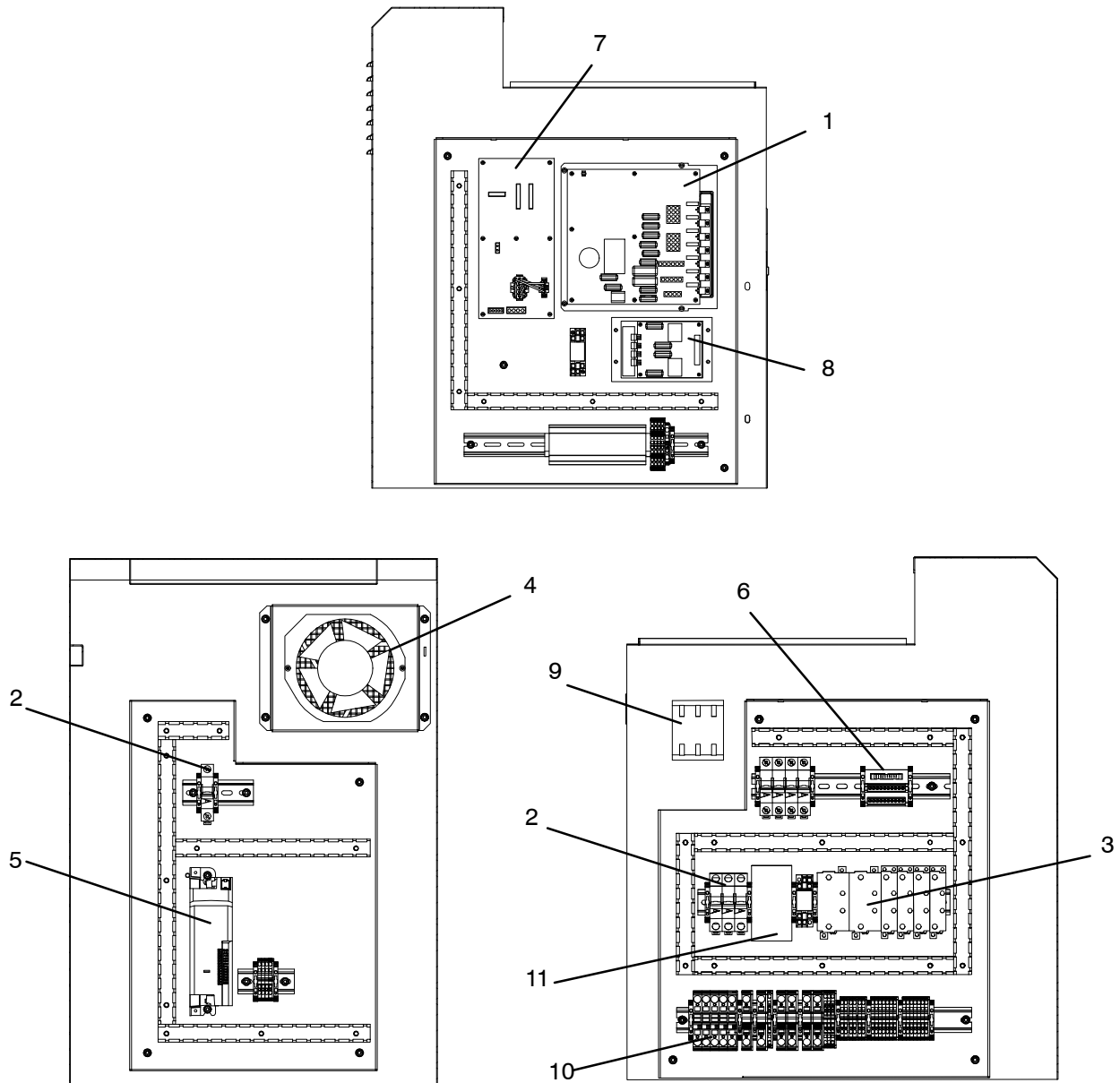

Figure 2-2 Key electrical components

- |                     |                      |                       |
|---------------------|----------------------|-----------------------|
| 1 Main board        | 5 Motor controller   | 9 Main switch         |
| 2 Circuit breakers  | 6 Signal conditioner | 10 Distribution block |
| 3 Solid state relay | 7 Expansion board    | 11 Contactor          |
| 4 Fan               | 8 Power module       |                       |

*Note:* The central processing unit is not shown in this illustration. Refer to Section 7, *Parts*.



## Control Panel

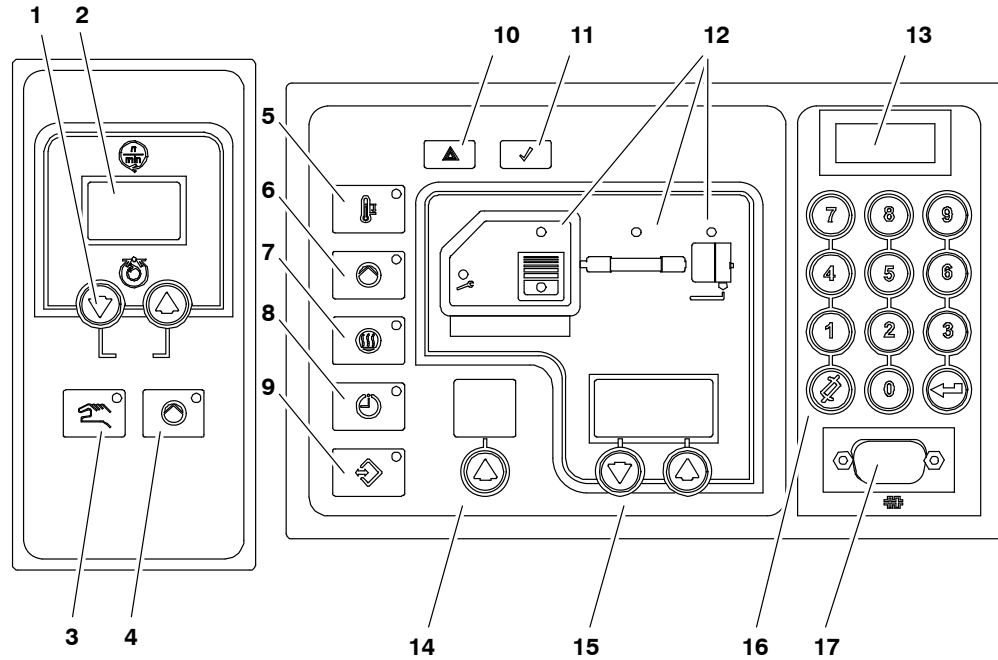

Figure 2-3 Control panel (melter control panel and two motor control panels shown)

- |                              |                        |                                 |
|------------------------------|------------------------|---------------------------------|
| 1 Pump speed arrow keys      | 7 Heaters key/LED      | 13 Control switch               |
| 2 Pump speed display (rpm)   | 8 Clock key/LED        | 14 Left display and arrow key   |
| 3 Pump mode key/LED          | 9 Setup key/LED        | 15 Right display and arrow keys |
| 4 Pump enable key/LED        | 10 Fault light         | 16 Numeric keypad               |
| 5 Standby key/LED            | 11 Ready light         | 17 Serial port                  |
| 6 Master pump enable key/LED | 12 Component keys/LEDs |                                 |

## Tank Isolation Valve

The tank isolation valve allows replacement of the pump without first emptying the tank.

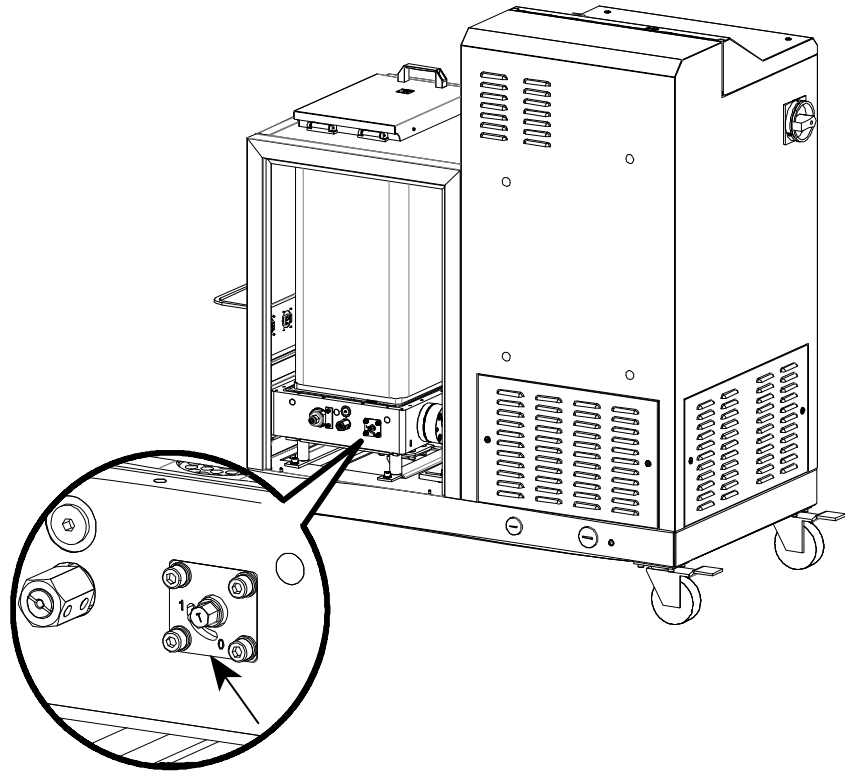

Figure 2-4 Location of the tank isolation valve

## Pressure Control Valves

The manual pressure control valves can be adjusted from 0-90 bar.

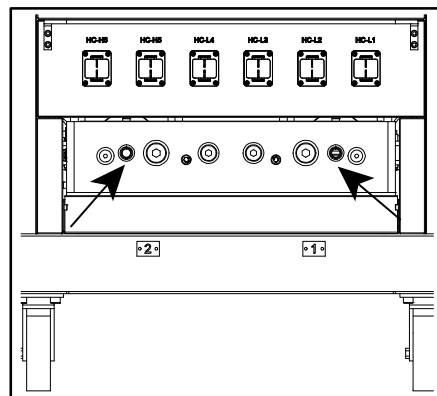

Figure 2-5 Location of the pressure control valves

## ***Modes of Operation***

DuraBlue II adhesive melters operate in the following modes.

### **Automatic Scan (Normal Mode)**

The melter automatically checks and displays the current temperature of the tank, hoses, and guns to confirm that they are within their pre-defined temperature range. By default, the melter is always in the automatic scan mode unless it is placed into another operating mode.

### **Standby**

The temperatures of the tank, hoses, and guns are reduced down from their operating temperature (hereafter referred to as set-point temperature) by a pre-set number of degrees.

### **Setup**

The setup mode is used to configure melter control options and features and to review stored operating data. To prevent unauthorized changes to the melter's configuration, the melter can be password-protected.

### **Fault**

The melter alerts the operator when an abnormal event occurs.

## ***Gear-to-Line Capability***

The melter is capable of delivering an adhesive output that is geared to the production line speed. The gear-to-line capability is enabled or disabled through the motor control system. A line-speed signal generator must be installed if you want to use the gear-to-line capability.

**NOTE:** The gear-to-line mode of operation is also known as automatic mode or key-to-line mode.

# Melter Identification

You will need the model and part number of your melter when requesting service or ordering spare parts and optional equipment. The model and part number are indicated on the equipment identification plate that is located on the front of the melter.

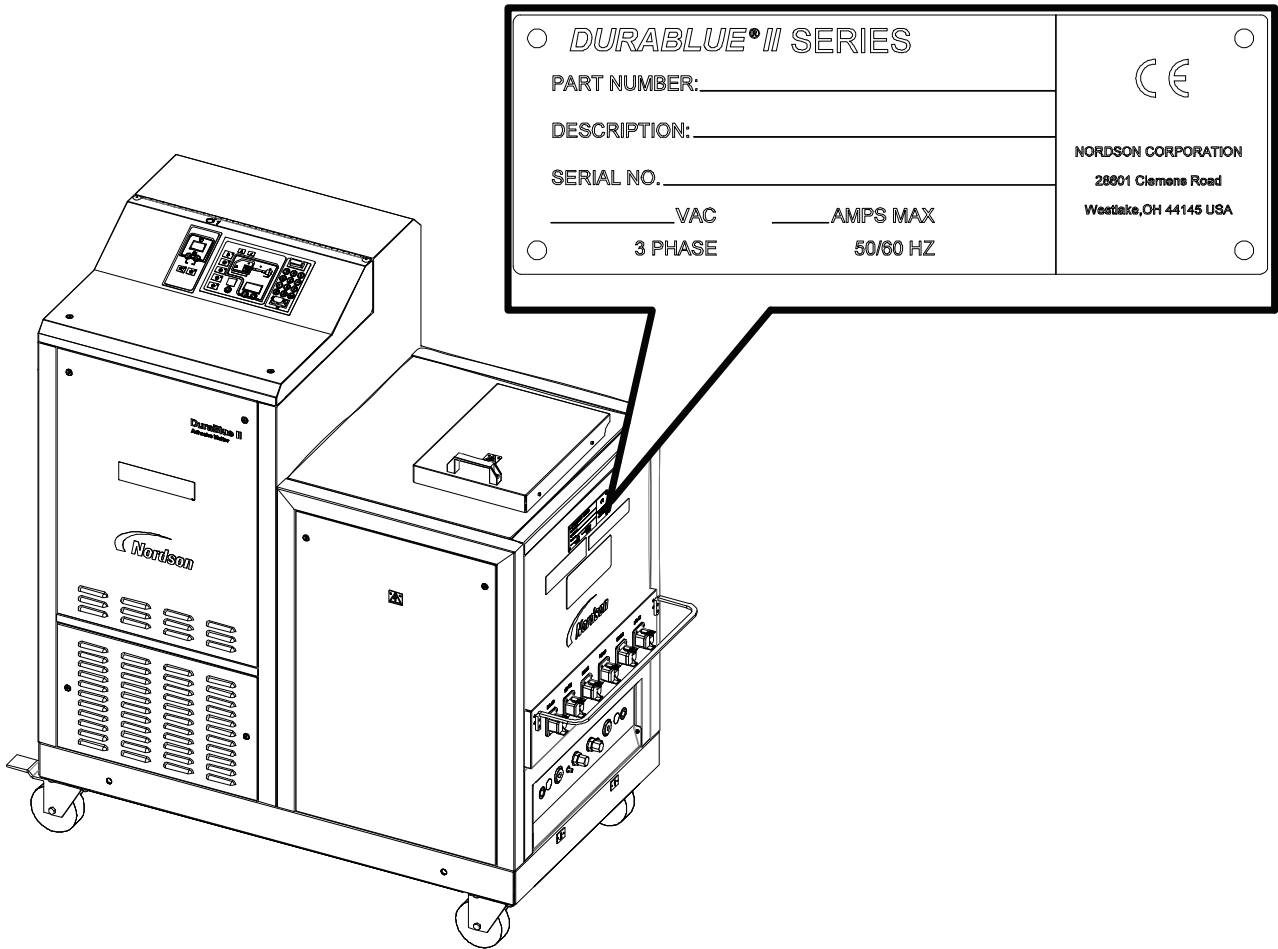

Figure 2-6 Location of the melter identification plate

## Section 3

# Installation



**WARNING!** Allow only qualified personnel to perform the following tasks. Follow the safety instructions in this document and all other related documentation.

## Overview

DuraBlue-II adhesive melters are factory-configured for each order and require only the assembly and set up tasks described in this section.

The melter is shipped from the factory with an installation kit that contains components that must be assembled onto the melter by the customer. Some additional materials must also be supplied by the customer to complete the installation.

If optional equipment was ordered with the melter, refer to the documentation provided with the optional equipment for installation and operating instructions.

The illustrations accompanying the procedures in this section depict a dual-motor dual-stream melter.

## Additional Information



This section presents installation procedures in their most commonly used form. Procedural variations or special considerations are explained in the additional information table that follows most procedures. Where applicable, some table entries also contain cross-reference information. Additional information tables are indicated by the symbol shown to the left.

## Installation Tasks

The installation sequence is as follows:

1. Verify that the required environmental conditions and utilities exist.
2. Unpack and inspect the melter.
3. Configure the electrical service.
4. Connect hot melt hoses and applicators.
5. (Optional) Configure key-to-line.
6. (Optional) Connect to the pressure control transducer.
7. Set up the melter to work with the manufacturing process.
8. (Optional) Install inputs and outputs.
9. Install optional equipment.
10. Connect an applicator driver, pattern controller, or timer.
11. Flush the melter.

## Experience of Installation Personnel

The instructions provided in this section are intended to be used by personnel who have experience in the following subjects:

- Hot melt application processes
- Industrial power and control wiring
- Industrial mechanical installation practices
- Basic process control and instrumentation

## *Installation Requirements*

Before installing the melter, ensure that the desired installation location provides the required clearances, environmental conditions, and utilities.

## Clearances

Figure 3-1 illustrates the minimum clearances that are required between the melter and surrounding objects.

Minimum Installation Clearances

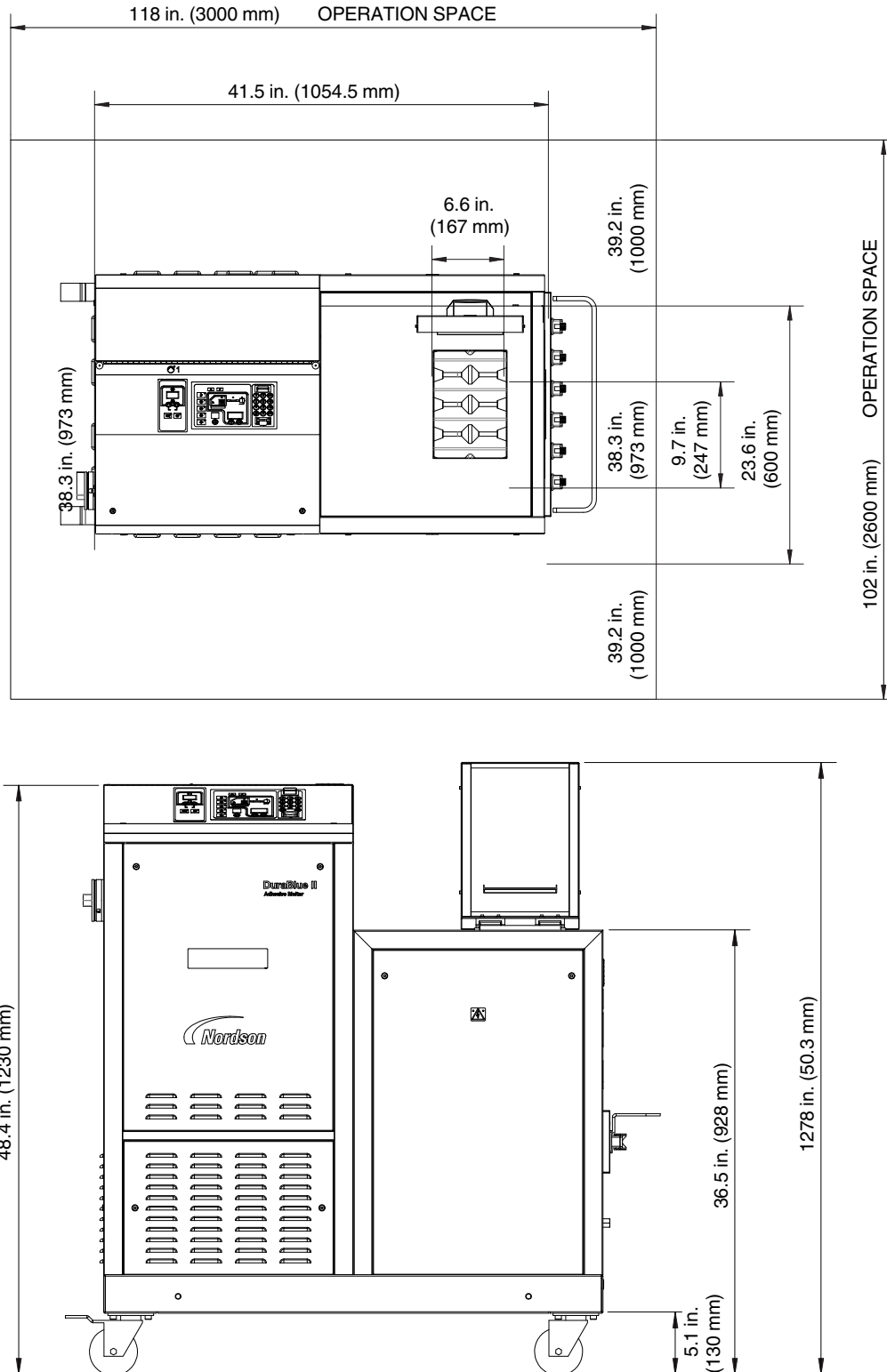

Figure 3-1 Melter minimum installation clearances

## Ventilation

DuraBlue II melters are cooled by forced air. Air is drawn in through by the ventilation fan and is exhausted out of the ventilation slots at the top of the melter.

**CAUTION!** Do not block the fan air intake openings or the exhaust ventilation slots.

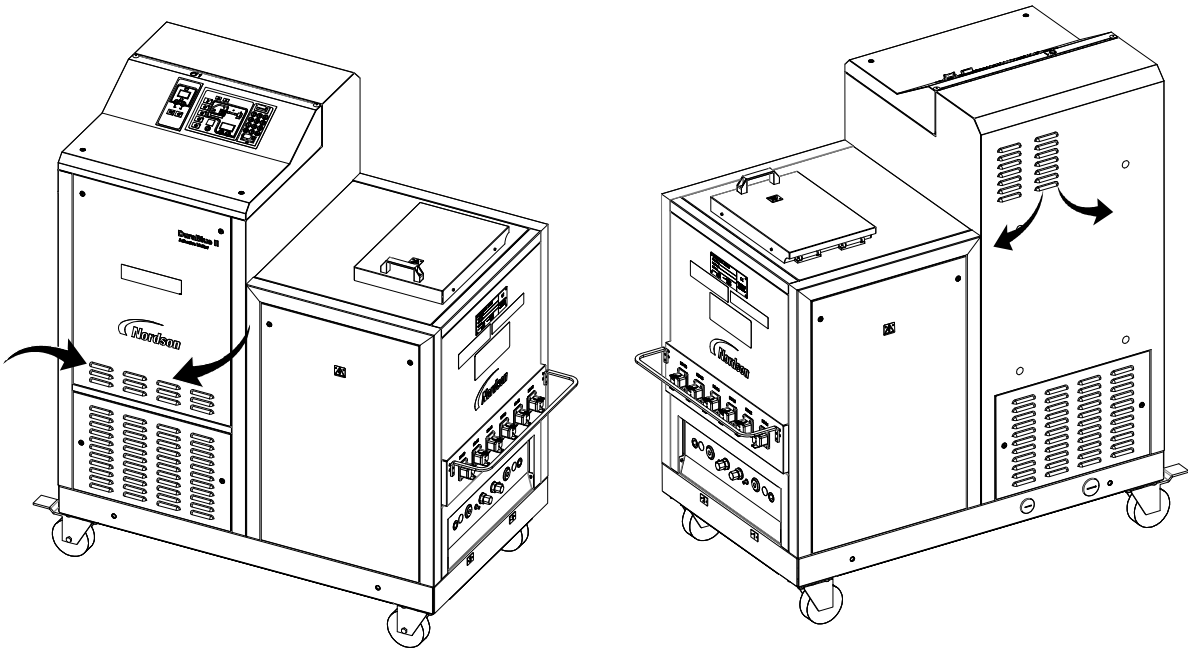

Figure 3-2 Location of the ventilation openings

## Electrical Power

Before installing the melter, ensure that the melter will not be overloaded and that the plant's electrical service is rated to handle the power required by the melter and the hoses and applicators that you plan to use.

Refer to Appendix A, *Calculating Melter Power Requirements*, for information about how to calculate the maximum allowable hose lengths and applicator wattages that can be used in your manufacturing application.



**WARNING!** Risk of electrocution! Install a lockable power disconnect switch between the electrical service and the melter. Failure to install or properly use the disconnect switch when servicing the melter can result in personal injury, including death.



## Other Considerations

Consider the following additional factors when evaluating where to install the melter.

- The maximum distance between the melter and each applicator is dictated by the power requirement of each hose. Refer to Appendix A, *Calculating Melter Power Requirements*, for information about how to determine the maximum allowable length.
- The operator must be able to safely reach the control panel and accurately monitor the control panel indicators.
- The operator must be able to safely observe the level of hot melt inside the tank.
- The melter must be installed away from areas with strong drafts or where sudden temperature changes occur.
- The melter must be installed where it will be in conformance with the ventilation requirements specified in the Safety Data Sheet for the hot melt being used.
- The melter should not be exposed to excessive vibration.

## ***Unpacking the Melter***

Before starting the installation, remove the melter from the pallet, locate the installation kit, and inspect the melter for damaged and missing parts. Report any problems to your Nordson representative.

## **Moving the Unpacked Melter**

When moving the melter, always support the melter by placing any lifting device under the chassis.

## **Contents of the Installation Kit**

The installation kit contains a package of safety label overlays that are printed in variety of languages. If required by local regulations, the appropriate language overlay should be applied over the English version of the same label. Refer to *Safety Labels and Tags* in Section 1, *Safety*, for the location of each safety label.

## **Customer-Supplied Materials**

The following additional materials are also required to install the melter.

- A power cable. Rigid or flexible electrical conduit will be required.
- (Optional) Gear-to-line input signal wiring
- (Optional) Input/output signal wiring

## Configuring the Electrical Service

DuraBlue II melters are shipped from the factory without an attached power cable. To configure the melter to function in your facility, you must connect a properly rated power cable.

The maximum power draw of the melter for any supported service code is 86 A.

### Residual Current Circuit Breakers

Local regulations in some geographic areas or industrial branches may require residual current circuit breakers.

Then observe the following points:

- Permanent installation is required (fixed line voltage connection)
- The residual current circuit breaker is to be installed only between the power supply and the melter.
- Only residual current circuit breakers sensitive to pulsating current or universal current (> 30 mA) may be used.

### Connecting the Electrical Service

**NOTE:** The melter must be installed securely (permanent power supply connection).



**WARNING!** Operate only at the operating voltage shown on the ID plate.

**NOTE:** Permitted deviation from the rated line voltage is  $\pm 10\%$ .

**NOTE:** The power cable cross-section must comply with the maximum power consumption (refer to Section 8, *Technical Data*).



**WARNING!** Ensure that cables do not touch rotating and/or hot melter components. Do not pinch cables and check regularly for damage. Replace damaged cables immediately!

1. See Figure 3-3. Route the power cable into the electrical cabinet through the strain relief on the side of the base.

**NOTE:** Do not route any input/output wiring through this strain relief.

2. Connect the power cable to the service terminal block as indicated in table Table 3-1 and illustrated in Figure 3-3.
3. Connect the service ground lead to the ground terminal located on the DIN rail at XL0:PE.

## Connecting the Electrical Service *(contd)*

Table 3-1 Electrical Service Wiring

Line voltage	Terminals				
	1	2	3	N	PE
400 V <sub>AC</sub> 3-phase with neutral (star - WYE)	●	●	●	●	●

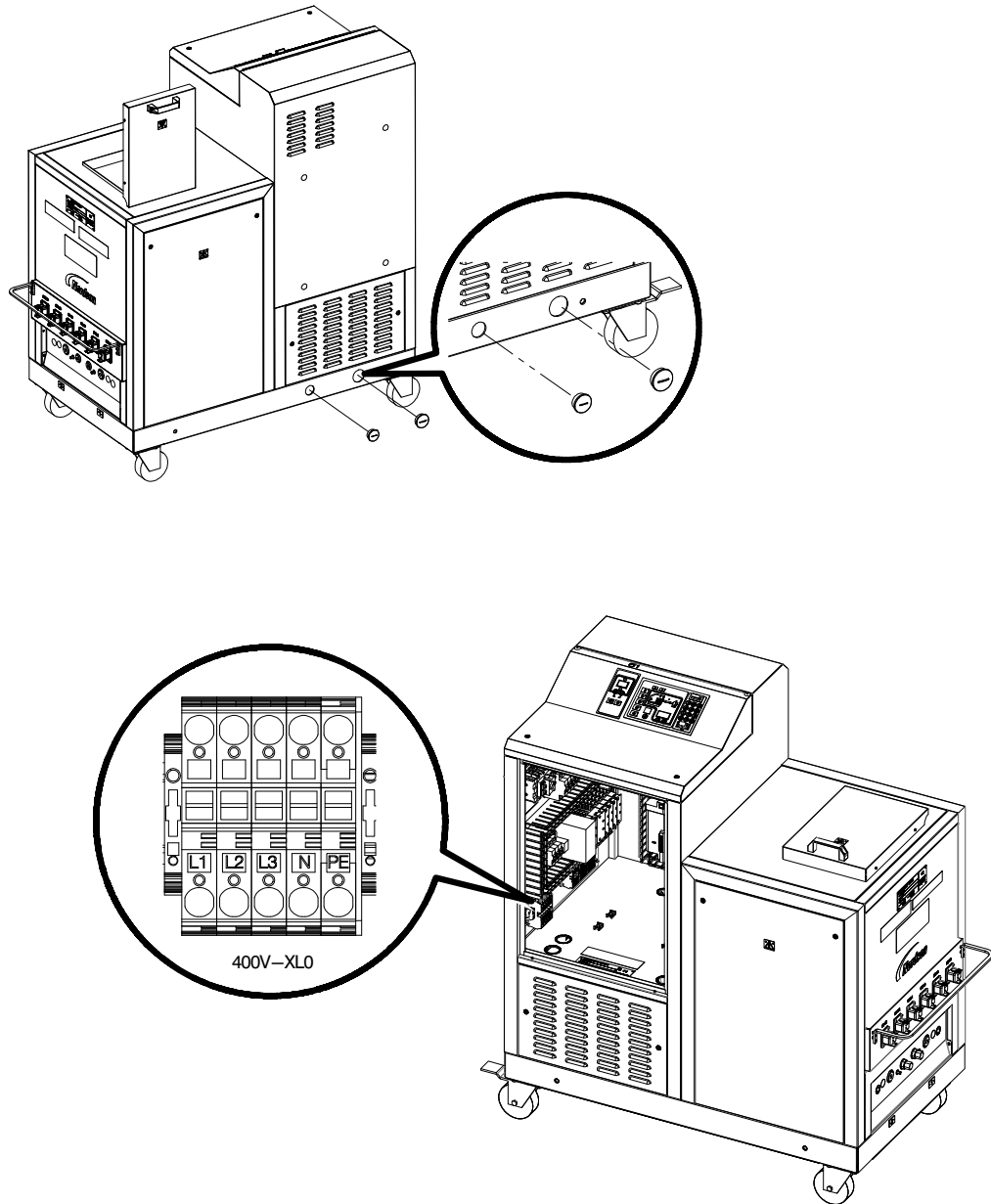

Figure 3-3 Location of service wiring strain relief and terminal block

---

## Connecting Hoses and Applicators



**WARNING!** Risk of fire or equipment damage. Before connecting hoses and applicators to the melter, confirm that the power required by each hose/applicator pair and each hose/applicator module, does not exceed the maximum wattages specified in Appendix A, Table A-2, *Maximum Allowable Wattages*.

### Connect Hoses

See Figure 3-4 to properly connect the hose hydraulic fittings based on the manifold configuration. If hoses are not connected properly, the melter will not operate correctly.

See Figure 3-5 to connect hose cordsets.

Observe the following guidelines:

- For information about choosing the correct Nordson hot melt hose for your manufacturing process, refer to the latest edition of Nordson's hot melt dispensing equipment *Replacement Parts Catalog* or contact your Nordson representative.
- Refer to the user's guide provided with each Nordson hose. The guide contains important information about routing and installing the hose.
- Save all of the port plugs removed from the manifold. A port plug will need to be reinstalled into the manifold if a hose is later removed.

## Connect Hoses *(contd)*

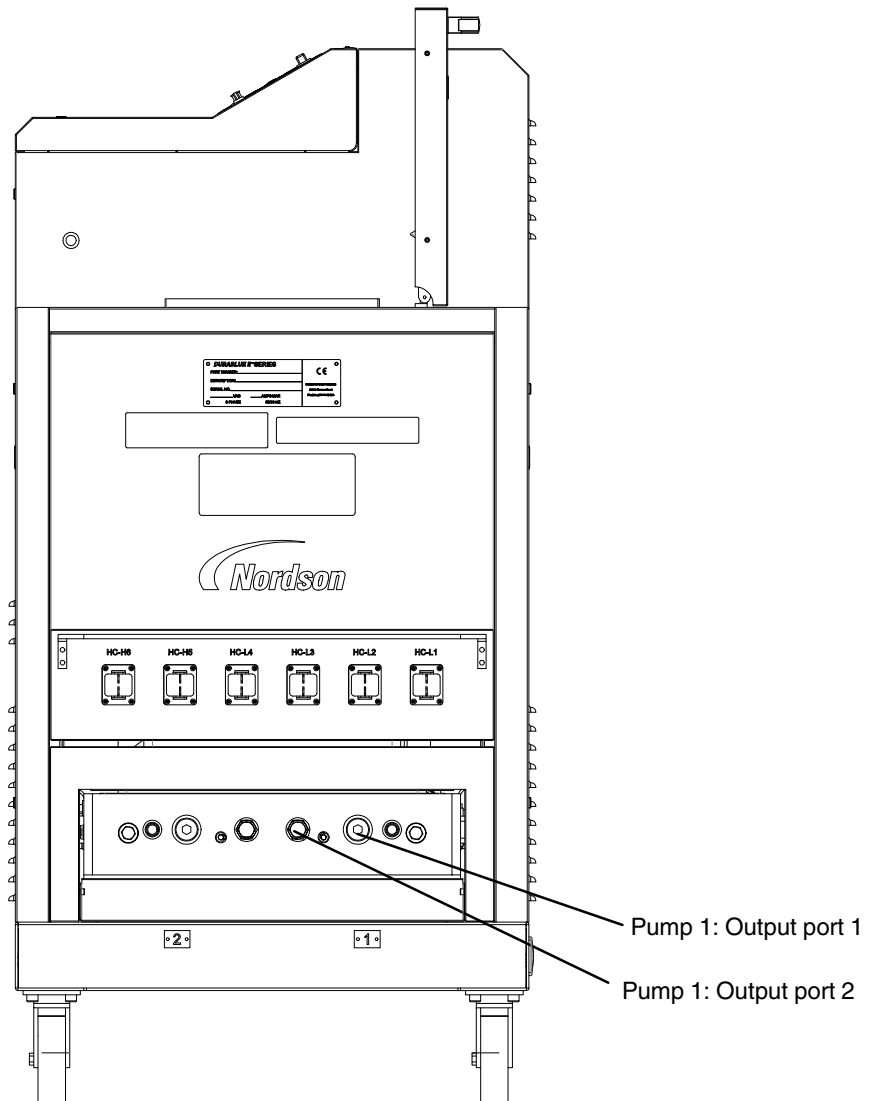

Figure 3-4 Connecting hoses

**Connect Hoses** *(contd)*

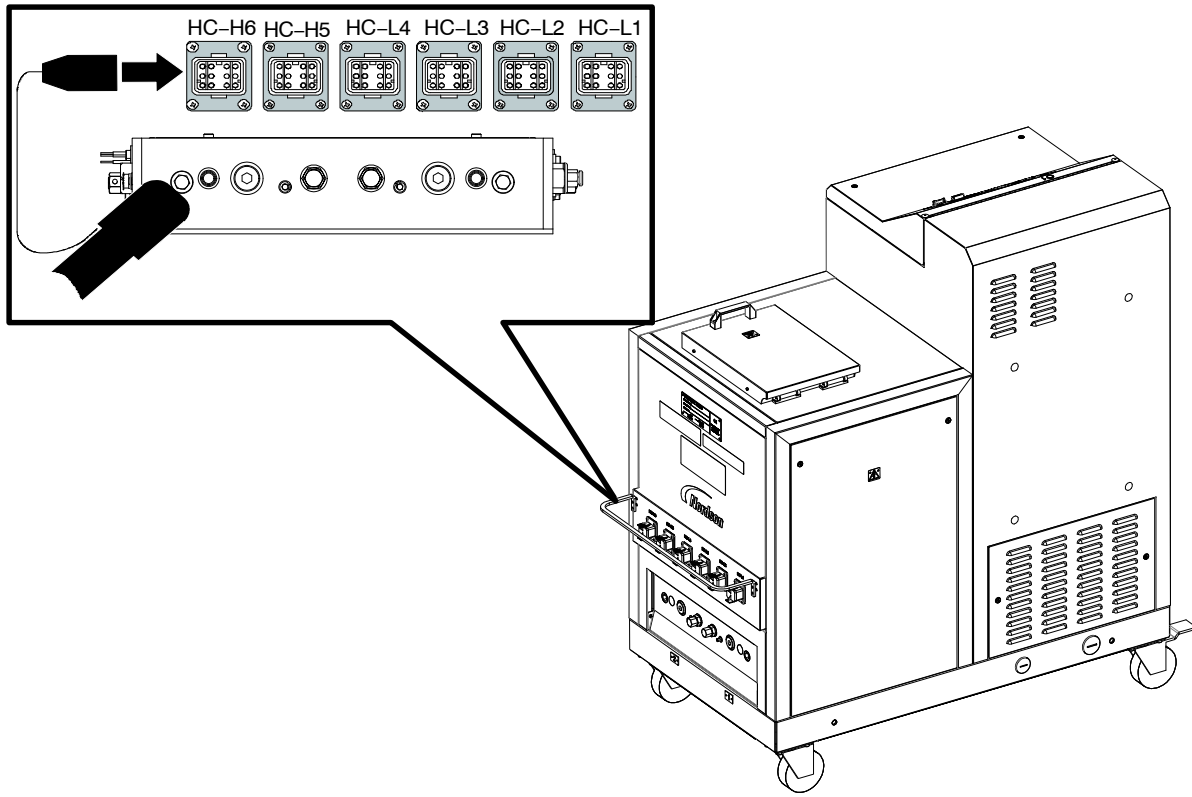

Figure 3-5 Connecting a hose cordset

## Connect Applicators

Observe the following guidelines:

- DuraBlue II melters with 120-ohm nickel sensors support all Nordson T-style applicators. DuraBlue-II melters with 100-ohm platinum sensors support all Nordson M-style applicators.
- For information about choosing the most appropriate Nordson hot melt applicator for your manufacturing process, refer to the latest edition of Nordson's hot melt dispensing equipment *Replacement Parts Catalog* or contact your Nordson representative. Refer to Appendix A, *Calculating Melter Power Requirements*, for information about how to calculate the power required by Nordson hot melt applicators.
- Refer to the user's guide that is shipped with each applicator for information about installing the applicator and connecting a hose to the applicator.

**NOTE:** DuraBlue II adhesive melters are shipped with a 0.2 mm hot melt filter installed in the manifold. Order the appropriate applicator nozzle based on this filter mesh size.



## ***Setting Up the Melter***

After physically installing the melter, it must be set up to support your manufacturing process. Melter setup consists of enabling or making changes to factory-set operating parameters that affect the use and function of the melter. The operating temperature (set-point) of the tank and each hose and applicator is also established during melter setup.

The melter is shipped from the factory with the most commonly used operating parameters already set up. The factory setup can be modified at any time to suit your manufacturing process.

### **Quick Setup**

Table 3-2 describes the most commonly used operating parameters and their factory settings. Review the table to determine if the factory settings for each parameter will support your manufacturing process. If the default values for each of these operating parameters are appropriate for your manufacturing process, then no melter setup is required. Go directly to *Set-point Temperature of the Tank, Hoses, and Applicators* later in this section to complete the installation process.

If you need to make changes to the factory setup or if you want to learn about other operating parameters, go to the next part in this section, *Operating Parameters*.

**Quick Setup** (contd)

Table 3-2 Common Operating Parameters

Parameter	Parameter Name	Purpose	Default Value
4	Ready Delay Time	A timer that delays the activation of the ready LED for a pre-defined time period after the tank, hoses, and applicators are at the desired set-point temperature. The ready delay timer will only activate if the temperature of the tank, at the time the melter is turned on, is below its assigned set-point temperature by 27 °C (50 °F) or more.	0 minutes
5	Service Interval Time	A timer that turns on a service LED when the value set for the timer equals the number of hours that the heaters have been on. The service LED is used to signal the need for maintenance.	500 hours
7	Motor Off Delay	If the switch receptacle is used, this parameter determines the amount of time the motor will remain on after the switched device is turned off.	0 seconds
8	Automatic Pump On	Allows the pump to start automatically when system ready is reached, provided that the pump has been enabled by pressing the pump key.	Enabled
11	Create Password	Sets a password that must be entered before any melter operating parameter or set-point temperature can be changed.	5000
20	Temperature Units	Sets the units of the temperature display to degrees Celsius (C) or to degrees Fahrenheit (F).	C
21	Over Temperature Delta	Sets the number of degrees that any heated component can exceed its assigned set-point temperature before an over temperature fault occurs.	15 °C (25 °F)
22	Under Temperature Delta	Sets the number of degrees that any heated component can drop below its assigned set-point temperature before an under temperature fault occurs.	25 °C (50 °F)
23	Standby Delta	Sets the number of degrees that the temperature of all heated components will be decreased when the melter is placed into the standby mode.	50 °C (100°F)
26	Manual Standby Time	Sets the amount of time the melter will remain in the standby mode after the standby key is pressed.	Disabled
50 to 77	Seven-day Clock	A group of parameters that control the melter's clock. The clock is used to automatically turn the heaters on and off and to place the melter into the standby mode.	Disabled

## Operating Parameters

The melter uses operating parameters to store non-editable and editable values. Non-editable values are those that provide information about the historical performance of the melter. Editable values are either a numeric set-point or a control option setting. Control options settings affect the display of information or the function of the melter.

Operating parameters are stored in the melter's firmware in the form of a sequentially numbered list. The list is organized into the logical groups described in Table 3-3.

Table 3-3 Parameter Groups

Group	Parameter Numbers	Group Description
Standard	0 to 8 and 10-14	Noneditable and other frequently used parameters
Temperature Control	20 to 29	Control heaters
Input Setup	30 to 39	Configure the standard and optional inputs
Output Setup	40 to 46	Configure the standard and optional outputs
Seven-day Clock	50 to 77	Configure the clock feature

In addition to the ability to read and edit parameter values, you can also save and restore the current value of every operating parameter and review a log of the last ten changes that were made to editable parameters.

### **Selecting Operating Parameters**

Table 3-4 provides a complete list of the operating parameters. Review the list to determine which operating parameters would best support your manufacturing process. Refer to Appendix B, *Operating Parameters*, for detailed information about each parameter. Appendix B contains a complete description of each parameter, including its affect on the melter, default value, and format.

**NOTE:** Parameters that are used to configure optional equipment or that are otherwise reserved in the firmware are excluded from Table 3-4 and Appendix B.

## Reading or Editing Operating Parameters

Regardless of whether a parameter's value is editable or not, the procedure for accessing each parameter in order to read or edit its current value is the same.

### To read or edit a parameter

1. Place the main power and control switches on the ON position.  
The melter performs a start-up check.

2. Press the **Setup** key.  
The left display flashes parameter 1.

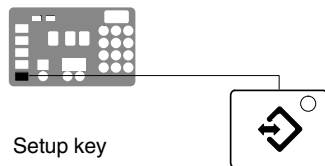

Setup key

3. Use the numeric keypad to enter the number of the desired parameter.  
Refer to Table 3-4 for a complete list of parameters.

**NOTE:** If you incorrectly enter the parameter number, press the **Clear/Reset** key to return to parameter 1 and then re-enter the correct parameter number.

When you have finished entering the one- or two-digit parameter number, the right display indicates the parameter's current value.

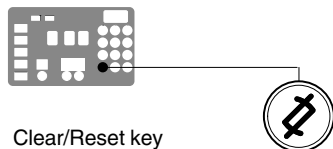

Clear/Reset key

4. Do *one* of the following:
  - If the value is noneditable, refer to *Monitoring the Melter* in Section 4, *Operation*.
  - If the value is editable go to step 5.

5. Press the **Enter** key.  
The right display flashes.

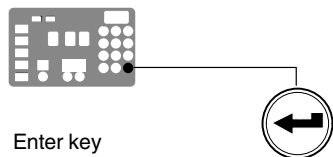

Enter key

6. Use the keypad to enter the desired numeric set-point or control option into the right display. Refer to Appendix B, *Operating Parameters*, for information about the numeric value or control option choices for each parameter.

**NOTE:** If the keypad has no effect on the right display, the melter is password protected. You must enter a valid password before you can edit parameters. Refer to *Entering a Password* in Section 4, *Operation*.

7. Press the **Enter** key.  
The melter checks that the new value or control option is acceptable.
  - If the numeric set-point or control option is accepted, the left and right displays index to the next sequential parameter number and value.

- If the numeric set-point or control option is not accepted, the right display will indicate dashes (----) for three seconds and then it will change back to the original value.

- Repeat step 5 through step 7 to read or change the next sequential parameter number or press the **Setup** key to exit the setup mode.

Table 3-4 Operating Parameters

Parameter	Name	Range of Values	Default Value
<i>Standard</i>			
0	Enter Password	0 to 9999	4000
1	Total Hours with Heaters On (noneditable)	0 to 9999	0
2	Fault Log (noneditable)	—	_-F0 (empty)
3	Change History Log (noneditable)	—	P-_ (empty)
4	Ready Delay Time	0 to 60 minutes	0 minutes
5	Service Interval Time	0 to 8736 hours	500 hours
6	Service LED Heater Hours	0 to 9999 hours	0
8 <sup>1</sup>	Automatic Pump On	0 (disabled) or 1 (enabled)	1 (enabled)
10	Enable or Disable Password	0 (disabled) or 1 (enabled)	0 (disabled)
11	Create Password	0 to 9999	5000
12 <sup>1</sup>	Change Hose 1 Output to Electric Applicator Activation	0 (disabled) or 1 (enabled)	0 (disabled)
13 <sup>1</sup>	Change Hose 2 Output to Electric Applicator Activation	0 (disabled) or 1 (enabled)	0 (disabled)
14	External Communications Lock-out	0 or 1	0 (disabled)
<i>Temperature Control</i>			
20	Temperature Units (degrees °C or °F)	C (degrees Celsius) or F (degrees Fahrenheit)	C (degrees Celsius)
21	Over Temperature Delta	5 °C (10 °F) to 60 °C (110 °F)	15 °C (25 °F)
22	Under Temperature Delta	5 °C (10 °F) to 60 °C (110 °F)	25 °C (50 °F)
23	Standby Delta	25 °C (50 °F) to 190 °C (350 °F)	50 °C (100 °F)
24	Automatic Standby Timeout	0 to 1440 minutes	0 (disabled)
25	Automatic Heaters Off Time	0 to 1440 minutes	0 (disabled)
26	Manual Standby Time	0 to 180 minutes	0 (disabled)
27	Hose Standby Delta	1 °C (1 °F) to 190 °C (350 °F)	0 (disabled)
28	Applicator Standby Delta	1 °C (1 °F) to 190 °C (350 °F)	0 (disabled)
29	Internal Zone Temperature Offset	0 °C (0 °F) to -15 °C (-30 °F)	0 (disabled)
30	Standard Input 1	0–8 and 10-14	10 (Automatic Standby)
31	Standard Input 2	0–8 and 10-14	1 (Standby on/off)
32	Standard Input 3	0–8 and 10-14	2 (Heaters on/off)
33	Standard Input 4	0–8 and 10-14	4 (Hose/applicator 1 enable/disable)
34	Optional Input 5	0–8 and 10-14	0 (disabled)
<sup>1</sup> Not used with DuraBlue II melters.			

## To read or edit a parameter (contd)

Parameter	Name	Range of Values	Default Value
<i>Input Setup</i>			
35	Optional Input 6	0-8 and 10-14	0 (disabled)
36	Optional Input 7	0-8 and 10-14	0 (disabled)
37	Optional Input 8	0-8 and 10-14	0 (disabled)
38	Optional Input 9	0-8 and 10-14	0 (disabled)
39	Optional Input 10	0-8 and 10-14	0 (disabled)
<i>Output Setup</i>			
40	Standard Output 1	0-6	1 (Ready)
41	Standard Output 2	0-6	3 (Fault)
42	Standard Output 3	0-6	4 (Not used)
43	Optional Output 4	0-6	0 (disabled)
44	Optional Output 5	0-6	0 (disabled)
45	Optional Output 6	0-6	0 (disabled)
46	Optional Output 7	0-6	0 (disabled)
<i>Seven-day Clock</i>			
50	Current Day	1 to 7 (1 = Monday)	—
51	Current Hour	0000 to 2359	—
55	Schedule 1 Heaters On	0000 to 2359	06:00
56	Schedule 1 Heaters Off	0000 to 2359	17:00
57	Schedule 1 Enter Standby	0000 to 2359	—:—
58	Schedule 1 Exit Standby	0000 to 2359	—:—
60	Schedule 2 Heaters On	0000 to 2359	—:—
61	Schedule 2 Heaters Off	0000 to 2359	—:—
62	Schedule 2 Enter Standby	0000 to 2359	—:—
63	Schedule 2 Exit Standby	0000 to 2359	—:—
65	Schedule 3 Heaters On	0000 to 2359	—:—
66	Schedule 3 Heaters Off	0000 to 2359	—:—
67	Schedule 3 Enter Standby	0000 to 2359	—:—
68	Schedule 3 Exit Standby	0000 to 2359	—:—
			<i>Continued...</i>

Parameter	Name	Range of Values	Default Value
71	Schedule for Monday	0-7	0
72	Schedule for Tuesday	0-7	0
73	Schedule for Wednesday	0-7	0
74	Schedule for Thursday	0-7	0
75	Schedule for Friday	0-7	0
76	Schedule for Saturday	0-7	0
77	Schedule for Sunday	0-7	0



You can exit the setup mode at any time by pressing the **Setup** key.

Parameter numbers that are not applicable are skipped when you scroll through the operating parameter list in the left display.

When the right display is flashing, you can quickly set the value of the current parameter to its lowest possible value by simultaneously pressing both of the right-display scroll keys.

While in the setup mode, if no key is pressed for two minutes, the melter will return to the automatic scan mode.

You can also use the right-display scroll keys to enter or change a parameter's value or control option. After entering the parameter's number in the left display, press either of the right-display scroll keys to change the value or control option.

Using a personal computer that is connected to the melter through the serial port, you can view and change all of the operating parameters from a single computer screen.

Refer to Appendix C, *Melter Communications*

If password protection is enabled, the melter will return to the password protected mode whenever you exit the setup mode.

Appendix B, *Parameter 10*

## Set-point Temperature of the Tank, Hoses, and Applicators

The melter is shipped from the factory with the tank set-point temperature at 175 °C (350 °F) and the hose and applicator set-point temperatures at 0 degrees (turned off).

Before the melter can be used, a set-point temperature must be assigned to the tank, hoses, and applicators. Assign set-point temperatures using any of the following methods:

- **Global**—The tank and all hoses and applicators are set to the same set-point temperature.
- **Global-by-component group**—All of the hoses or all of the applicators are set to the same set-point temperature.
- **Individual Component**—The set-point temperature of the tank and each hose and applicator is set individually.

Since most manufacturing processes will require the tank, hoses, and applicators to be set to the same temperature, only the global method of assigning set-point temperatures is described in this section. For information about the other two methods of assigning set-point temperatures, refer to *Adjusting Component Temperatures* in Section 4, *Operation*.

As with operating parameters, you can also save and restore set-point temperatures and review past changes that were made to set-point temperatures.

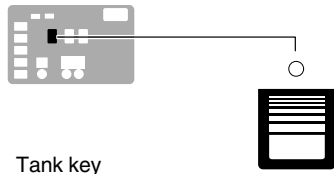

**To assign a global set-point temperature**

Tank key

1. Press and hold the **Tank** key for three seconds.  
The left display flashes 1.

2. Scroll the left display to 0.

The right display indicates all dashes (---) and the LEDs on the tank, hose, and applicator keys turn green.

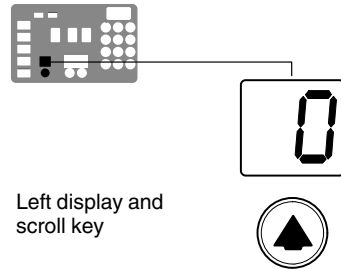

Left display and scroll key

3. Press the **Enter** key.  
The right display flashes.

4. Use the numeric keypad to enter the set-point temperature recommended by the manufacturer of the hot melt.

Refer to the technical data sheet provided by the manufacturer of the hot melt to determine the optimal set-point temperature.

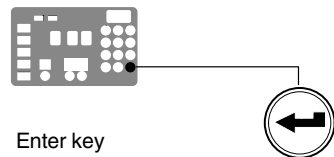

Enter key

5. Press the **Tank** key.

Each component begins to heat or cool to the new global set-point temperature and the melter returns to the automatic scan mode.

When all of the components reach the global set-point temperature, the ready LED turns on (green).

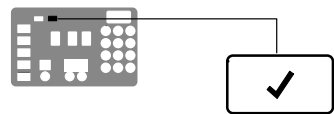

Ready LED

## Save and Restore Melter Settings

The current value of all editable operating parameters and the set-point temperature of each component can be saved and, if necessary, restored at a later time. When saved settings are restored, they overwrite the settings that are presently in use.

This save-restore feature is useful in instances where the settings that are in use are deliberately or accidentally changed and you need to return the melter to its pre-change setup.

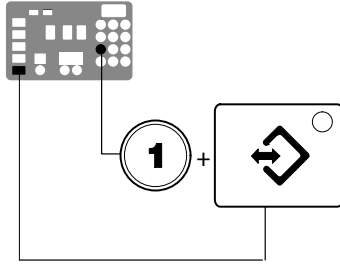

Saving current settings

### To save current settings

With the melter in the automatic scan mode, simultaneously press the number **1** key and the **Setup** key.

S-1 appears momentarily in the right display.

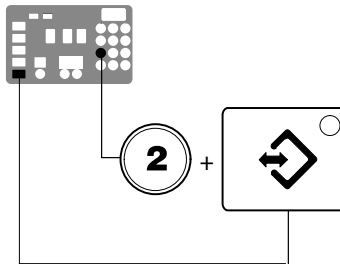

Restoring saved settings

### To restore saved settings

**CAUTION!** All melter settings will be deleted! Before restoring saved settings, ensure that use of the restored settings will not disrupt the current process or create an unsafe operating condition.

With the melter in the automatic scan mode, simultaneously press the number **2** key and the **Setup** key.

S-2 appears momentarily in the right display.



If you use the restore feature before the save feature is used for the very first time, the factory default set-point temperatures will be restored. This will cause the hoses and applicators to stop heating.

You can transfer melter settings from one melter to another using the Nordson Configuration Manager software utility.

Refer to Appendix C, *Melter Communications*

## Review Parameter and Set-point Temperature Changes

The melter stores in a change history log, a record of the last ten changes that were made to either operating parameters or set-point temperatures. Since the log only stores ten changes, old log entries are overwritten beginning with the first log entry, by the eleventh and following log entries.

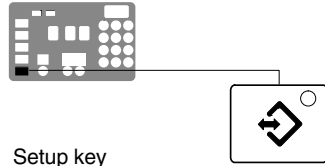

Setup key

### To review the change history log

1. Press the **Setup** key.

Operating parameter 1 flashes in the left display.

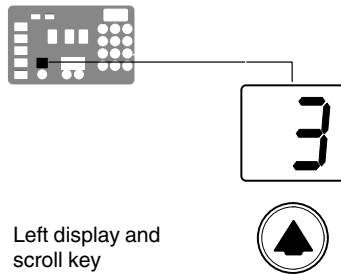

Left display and scroll key

2. Press the left-display scroll key to change the display to parameter 3 (the change history log).

The following occurs:

- If the last change was to an editable parameter, all of the component key LEDs remain off.
- or*
- If the last change was to a set-point temperature, the LED on the associated component key(s) turns on.

*and*

- The right display indicates the four-digit log entry associated with the *last* change that was made.

Table 3-5 provides the meaning, from left to right, of each digit in the log entry. Following the table are two example log entries.

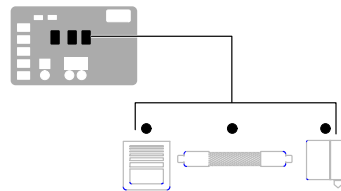

Component key LEDs

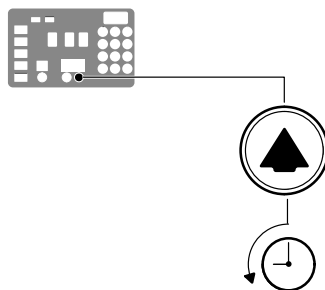

Scrolling through the log

3. Press a right-display scroll key to review each of the remaining nine log entries. Each press of a scroll key displays a progressively older log entry.
4. Press the **Setup** key to return to the automatic scan mode.

## Review Parameter and Set-point Temperature Changes (contd)

Table 3-5 Change History Log

First Digit	Second Digit	Third and Fourth Digits			
<b>P</b> (Parameter)		<i>Indicates the number of the parameter that was changed</i>			
		<i>Are used in conjunction with the LEDs on the component keys to indicate the location and method of a set-point temperature change.</i>			
<b>S</b> (Set-point)	-	<b>When this LED is on..</b>	<b>And the Fourth Digit Indicates..</b>	<b>The change was to..</b>	<b>And the Method of Change was..</b>
		Tank Key	1	The tank	Individual
		Hose Key	1– 6	A single hose	Individual
		Applicator Key	1– 6	A single applicator	Individual
		All Keys	0	All components	Global
		Hose Key	0	All hoses	Global-by-component
		Applicator Key	0	All applicators	Global-by-component

### Change History Log Examples

Example 1:

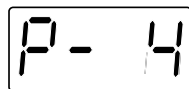

Parameter 4 (ready delay) was changed.

Example 2:

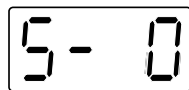

If the LED on the applicator key is on, then this display would indicate that the global-by-component method was used to change the temperature of the applicators.



Unused log entries in the change history log are indicated by "P-\_" in the right display.

To view how many heater hours have elapsed since a specific change (displayed) was made, simultaneously press both of the right-display scroll keys.

## Setting Up Inputs/Outputs

DuraBlue II adhesive melters are equipped with four standard inputs. Each input is customer-wired to the melter and then set up to provide one of the following control options:

- Place the melter into the standby mode
- Turn the heaters on and off
- Enable or disable a specific hose or applicator
- Enable the motor

The input contacts use a constant 10 to 30 VDC signal voltage. The inputs are not polarity sensitive.



**WARNING!** The operator can override the melter inputs by using the control panel function keys. Ensure that the control logic for any external device that sends an input signal to the melter is programmed to prevent the creation of an unsafe condition in the event that the operator overrides an external input to the melter.

The melter is also equipped with three user-configurable outputs. Outputs are used to communicate with user-supplied production equipment or control hardware, such as a programmable logic controller.

Each output is customer-wired and then set up in the melter's firmware to provide one of the following outputs:

- The melter is ready
- The melter is ready *and* the motor is enabled
- A fault has occurred
- The hot melt level is low (only if the optional level switch is installed)
- The service LED is on

All outputs contacts are rated at 240 VAC 2 A or 30 VDC 2 A. All contacts are normally open when the melter is turned off.

## Wire Inputs/Outputs to the Melter

See Figure 3-6.

1. Route a 2-, 4, 6, or 8-conductor signal cable from the control equipment to the melter and through the PG-16 penetration on side of the base. Use rigid or flexible conduit or a suitable strain relief to protect the cable from the sharp edge of the conduit penetration.

**NOTE:** Use a signal cable suitable for NEC class 1 remote control and signaling circuits. To reduce the possibility of electrical shorting, route the cable so that it does not touch nearby circuit boards.

2. Connect each pair of input and output wires to the appropriate terminals on terminal block XI. Refer to Table 3-6 for the terminal numbers that correspond to each input.

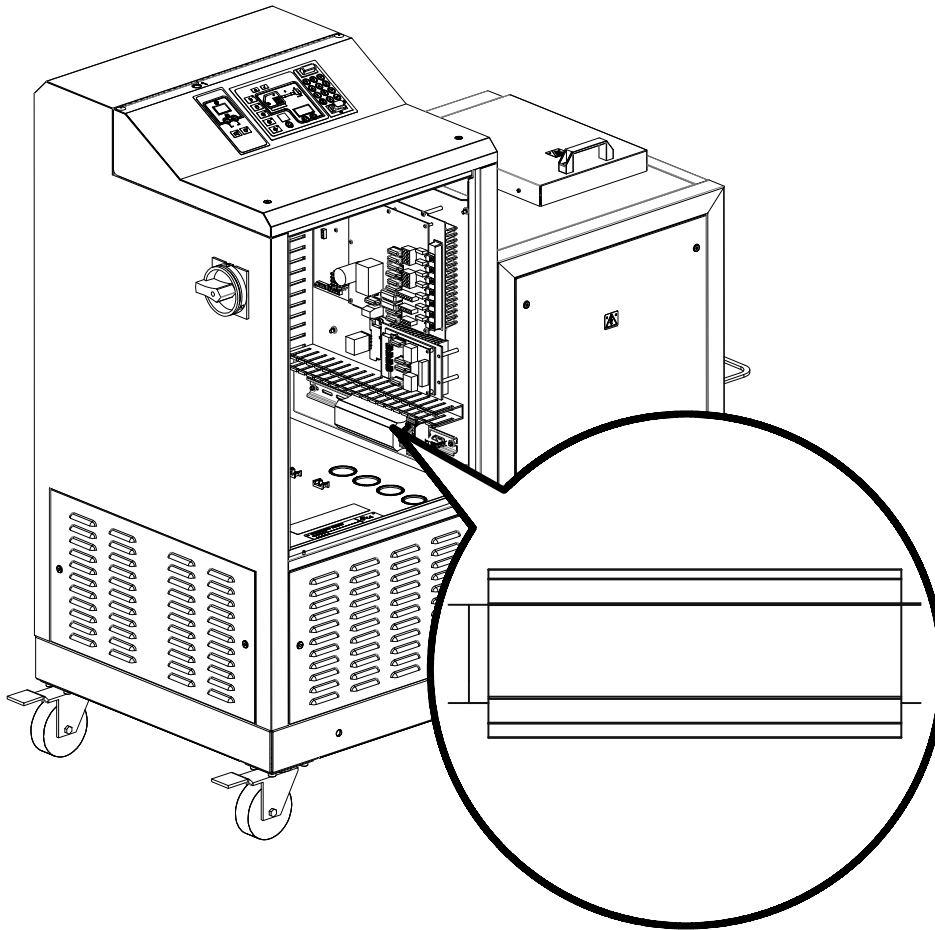

Figure 3-6 Location of the XI terminal block for connecting input/output wiring



## Set Up Inputs/Outputs *(contd)*

Item	Description	Operating Parameter	Control Options	Terminals	Notes
2	Standard input 2	31	0 - Input Disabled 1 - Standby On/Off (Default) 2 - Heaters On/Off 3 - Motor 1 Enable/Disable 4 - Hose/Applicator 1 Enable/Disable 5 - Hose/Applicator 2 Enable/Disable 6 - Hose/Applicator 3 Enable/Disable 7 - Hose/Applicator 4 Enable/Disable 8 - Hose/Applicator 5 Enable/Disable 9 - Hose/Applicator 6 Enable/Disable 11 - Motor 2 Enable/Disable	XI:3, XI:4	C           C
3	Standard input 3	32	Same as parameter 31 (Default=2)	XI:5, XI:6	
4	Standard input 4	33	Same as parameter 31 (Default=4)	XI:7, XI:8	
5	Standard output 1	40	0 - Output Disabled 1 - Ready (Default) 2 - Ready and the Motor is On 3 - Fault 4 - Tank Low Level 5 - Service LED is On 6 - Alert	XI:9, XI:10	F F F G   H
<p><b>NOTE</b> A: Parameter 30 has 12 control options. parameters 31, 32, and 33 each have only 11 control options.</p> <p>B: Parameters 34 through 39 are reserved for the six inputs created when the optional I/O expansion card is installed. The six optional inputs have the same control options as parameter 31.</p> <p>C: Parameters are disabled in DuraBlue II adhesive melters. Refer to parameters 9-12 in this table.</p> <p>D: If control option 10 is selected for input 1, a time must be set in parameter 24.</p> <p>E: Refer to the instruction sheet provided with the optional I/O expansion card for wiring information.</p> <p>F: When control option condition occurs, contacts close. Contacts are normally open when power is off.</p> <p>G: When control option condition occurs, contacts open. Contacts are normally open when power is off.</p> <p>H: Control option 6 provides an output signal when a potential fault is detected. If control option 3 and 6 are both used, then both a fault output and an alert output signal will be present when the fault LED turns on.</p> <p>I: For wiring information, refer to the instruction sheet that is provided with the optional I/O expansion card</p>					
					<i>Continued...</i>



Table 3-6 Input/Output Data (contd)

Item	Description	Operating Parameter	Control Options	Terminals	Notes
6	Standard output 2	41	Same as parameter 40 (Default=3)	XI:11, XI:12	
7	Standard output 3	42	Same as parameter 40 (Default=4)	XI:13, XI:14	
8	Key-to-line 0-10V input	—		XI:15 (+), XI:16 (-)	Refer to <i>Setting Up Gear-to-Line Operation</i>
9	Motor 1 remote start	—		XI:17, XI:18	Connect a momentary, normally open contact to the terminals.
10	Motor 1 remote stop	—		XI:19, XI:20	Connect a momentary, normally open contact to the terminals.
11	Motor 2 remote start	—		XI:21, XI:22	Connect a momentary, normally open contact to the terminals.
12	Motor 2 remote stop	—		XI:23, XI:24	Connect a momentary, normally open contact to the terminals.
					<i>Continued...</i>

## Set Up Inputs/Outputs *(contd)*

Table 3-6 Input/Output Data *(contd)*

Item	Description	Operating Parameter	Control Options	Terminals	Notes
13	Motor 3 remote start (See Note J)	—		XI:29, XI:30	Connect a momentary, normally open contact to the terminals.
14	Motor 3 remote stop (See Note J)	—		XI:31, XI:32	Connect a momentary, normally open contact to the terminals.
15	Motor 4 remote start (See Note J)	—		XI:33, XI:34	Connect a momentary, normally open contact to the terminals.
16	Motor 4 remote stop (See Note J)	—		XI:35, XI:36	Connect a momentary, normally open contact to the terminals.
17	Motor drive 1 running (optional)	—		XI:25, XI:26	Refer to <i>Setting Up Motor Run Status Monitoring</i> .
18	Motor drive 2 running (optional)	—		XI:27, XI:28	
19	Motor drive 3 running (optional) (See Note J)	—		XI:37, XI:38	Refer to <i>Setting Up Motor Run Status Monitoring</i> .
20	Motor drive 4 running (optional) (See Note J)	—		XI:39, XI:40	
J: Motors 3 and 4 are present only on three/four pump or 100L melters.					

## ***Setting Up Gear-to-Line Operation***

If you want to use the gear-to-line capability, install a (customer-supplied) line-speed signal generator to measure the speed of the production line. The AltaBlue motor control accepts a 0-10 VDC analog input signal.

**NOTE:** Nordson offers a 0-10 VDC line-speed signal generator. Refer to *Optional Accessories* in Section 7, *Parts*, for the part number.

To use the gear-to-line capability, connect a 0-10 VDC signal from a customer-supplied line-speed signal generator to the appropriate terminals on terminal block XI inside the electrical enclosure. See Figure 3-6 for the location of terminal block XI. Refer to Table 3-6 for the terminal numbers that correspond to each input/output.

# Setting Up Motor Run Status Monitoring

If desired, you can set up the melter to allow remote monitoring of the run status (running or not running) of the pump motors.

## Wiring







To use the motor run status monitoring capability, connect wiring from the parent machine to the appropriate terminals on terminal block XI inside the electrical enclosure. See Figure 3-6 for the location of terminal block XI. Refer to Table 3-6 for the terminal numbers that correspond to each input/output.

**NOTE:** The relay contact between terminals XI:25/XI:26 and XI:27/XI:28 is normally open. When the motor is running, these contacts should close.

## Keypad Buttons

The motor driver keypad is not shipped with the melter, in order to use the keypad you will need to order the keypad service kit (P/N 7411739) separately.

An explanation of the keypad button functions is given in the following table.

Keypad	Buttons	Description
		<ul style="list-style-type: none"> <li>• Menu navigation (UP/Down).</li> <li>• Adjust parameter values.</li> </ul>
		<ul style="list-style-type: none"> <li>• Enter (sub-) menu/parameter.</li> <li>• Confirm parameter.</li> </ul>
		<ul style="list-style-type: none"> <li>• Exit (sub-) menu/parameter.</li> </ul>
		<ul style="list-style-type: none"> <li>• Stop inverter</li> </ul>
		<ul style="list-style-type: none"> <li>• Release inverter</li> </ul>









## Programming



DuraBlue-II service kit motor drive keypad

This parameter comes pre-set at the factory.

Use the service kit motor drive keypad, PN 7411739 to set up the motor run status monitoring for each motor. Refer to *Changing a Motor Drive Parameter* in Section 6, *Troubleshooting*, for a detailed procedure for changing a motor drive parameter.

1. Press  (ENT) until the Group Screen is displayed.
2. Press  (UP) until Group 4 is displayed.
3. Press  (ENT) to access I/O parameters.
4. Press  (UP) to select the parameter until "P420.00" is displayed.
5. Press  (ENT) to select the sub parameter.
6. Press  (UP) to select P420.01.
7. Press  (ENT) to set parameter.
8. Press  (UP) to change parameter until 51 is displayed.
9. Press  (ENT) >3S to save parameters to memory.

## ***Installing Optional Equipment***

Each item of optional equipment is shipped with instructions for installing and operating the equipment. Refer to Section 7, *Parts*, for equipment part numbers.

## ***Connecting an Applicator Driver, Pattern Controller, or Timer***

If applicable, complete the melter installation by connecting the applicators to the desired applicator driver, pattern controller, or timer. Refer to the product manual provided with the device for information about installing and operating the equipment.

## ***Flushing the Melter***

Before using the melter for production, it should be flushed to remove any residue left over from factory-testing. Flushing the melter is accomplished by processing a minimum of one tank volume of hot melt through the melter, hoses, and applicators.

Refer to Section 4, *Operation*, for information about filling the tank and operating the melter.

## ***Disposing of Melter***

When your Nordson product has reached the end of its useful life, dispose of it in accordance with local regulations.

## Section 4

# Operation



**WARNING!** Allow only qualified personnel to perform the following tasks. Follow the safety instructions in this document and all other related documentation.

This section provides information about the following operator-level tasks:

- Filling the melter tank
- Starting the melter
- (Optional) Adjusting the speed of the motor(s)
- (Optional) Adjusting material pressure
- Monitoring melter operation
- Adjusting the operating temperature of heated components
- Using the melter function keys
- Shutting the melter down

Most of the controls described in this section are located on the control panel. Refer to *Key Components* in Section 2, *Introduction*, for the location of the controls and indicators described in this section.

## ***Additional Information***



This section presents operating procedures in their most commonly used form. Procedural variations or special considerations are explained in the additional information table that follows most procedures. Where applicable, some table entries also contain cross-reference information. Additional information tables are indicated by the symbol shown to the left.

## Filling the Tank

**CAUTION:** Before filling the tank, ensure that tank and material are clean and free of foreign substances. Foreign substances can hinder functioning or even cause damage to the melter or accessories.

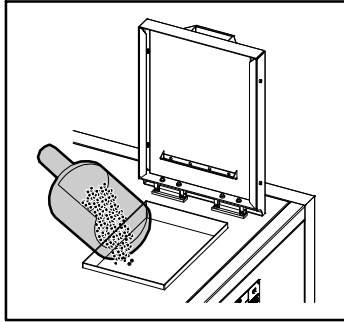

Filling the tank

**CAUTION:** Cease operation before the tank is completely empty. If there is too little material in the tank, the material can overheat. Overheated material can char, collect on surfaces and cause malfunctioning.

1. Use a scoop to pour material into the tank, leaving a minimum of 2.54 cm (1 in.) of space between the top of the material and the top of the tank.
2. Close the lid after filling the tank.

## About Heated Components

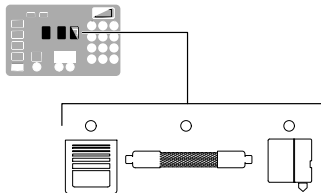

Component keys  
(tank, hose, and applicator)

The melter contains three groups of heated components. These are the tank group, which contains tank, the grid, and the reservoir; the hose group; and the applicator group. Component groups are represented on the control panel by the component keys shown to the left.

Heated components within each group are identified by their position number. The position of the tank group is fixed at 1. Hose and applicator position numbers are automatically assigned based on the hose/applicator receptacle they are connected to.

**NOTE:** In some installations, auxiliary devices (such as a heated air manifold) may be connected to a hose/applicator receptacle. In such cases, you should label (or otherwise identify) the auxiliary device as to the hose or applicator position number that represents the device. The control panel will identify such devices as a hose or applicator, regardless of what the device actually is.



# Starting the Melter

Before starting the melter for the first time, confirm that the

- melter is fully installed including any required inputs and outputs, applicator drivers, pattern controllers, or timers.
- melter's operating parameters are set up to support the current manufacturing process.

Refer to Section 3, *Installation*, if any of the items listed above are not complete.

## To start the melter

1. Place the main power switch in the ON position.
2. Place the control switch in the ON position.

The melter:

- Tests the control panel LEDs
- Turns on the heaters (the heaters LED turns green)
- Begins to automatically scan through and display the actual temperature of the tank and each hose and applicator that has a set-point temperature that is greater than zero degrees. The sequence of the automatic scan is: tank, each hose and applicator pair, and then back to the tank.
- Turns on the ready LED (green) when the tank and all of the hoses and applicators are within 3 °C (5 °F) of their assigned set-point temperature.

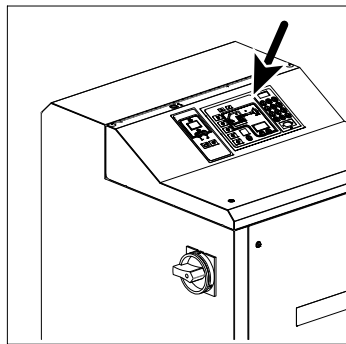

Control switch

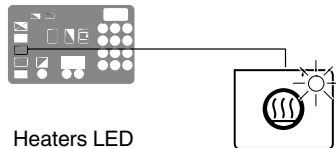

Heaters LED

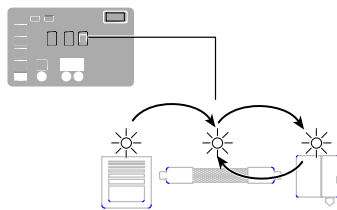

Automatic scan sequence

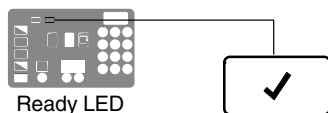

Ready LED

## Starting the Melter (contd)

**CAUTION!** Do not operate Nordson pumps without material. Before enabling the motor(s), ensure that the tank is filled.

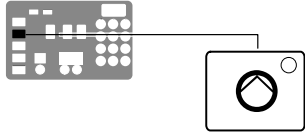

Master pump enable key/LED

3. Press the master pump enable key to enable the pump(s).

The LED on the key turns yellow to indicate that a pump is enabled, but not running.

4. **Melters equipped with the optional motion switch:** Place the motion switch in the ON position.

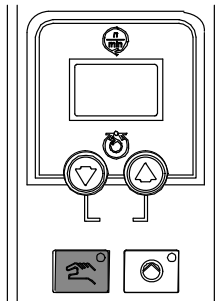

Pump mode key and LED

5. Press the pump mode key(s) to select the manual (LED on) or automatic (LED off) mode.

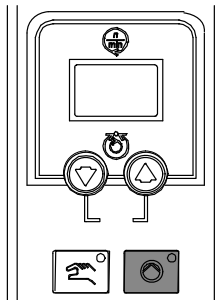

Motor start/stop key and LED

6. Press the pump enable key(s) on the motor control panel(s) to enable the motor(s). The LEDs turn on when a motor is enabled:

**Manual Mode**—If the system is at ready status (master pump enable key LED is green) at the time a pump enable key is pressed, then the motor(s) will start. If the system is not at ready status (master pump enable key LED is yellow), wait until the LED is green, and then repress the pump enable key(s).

**Automatic Mode**—If the system is at ready status (master pump enable key LED is green) at the time a pump enable key is pressed, then the motor(s) will start. If the system is not at ready status (master pump enable key LED is yellow), the motor(s) will start automatically when the system reaches ready.

**NOTE:** If any one of standard inputs 1-4 (Parameters 30-33) are being used *and* if either control option 3 (Motor 1 Enable/Disable) or control option 11 (Motor 2 Enable/Disable) is selected, the pump enable keys have no effect. Refer to *Setting Up Inputs/Outputs* in Section 3, *Installation*, for information on connecting and setting up inputs/outputs.



If the melter is switched on when the temperature of the tank is 27 °C (50 °F) or greater below its assigned set-point temperature (cold start condition), the ready LED will not turn on until the ready delay (defined when the melter was set up) has elapsed.

Appendix B, Parameter 4

The time remaining on the ready delay (in minutes) appears in the right display at the end of every scan cycle. When only one minute remains in the ready delay time, the right display counts down in seconds.

Appendix B, Parameter 4

You can by-pass the ready delay time by pressing the **Heaters** key twice.

The appearance of F4 in the right display immediately after the melter is switched on indicates a problem with the melter's processor or main board.

*Monitor Melter Faults*

The appearance of F1 in the right display immediately after starting the melter indicates that a hose or applicator cordset may be loose or disconnected.

Section 6, *Troubleshooting*

The condition of one or more inputs, may prevent the heaters from turning on.

*Installing Melter Inputs* in Section 3, *Installation*

If the seven-day clock feature was set up and turned on when the melter was last switched off, the clock will automatically turn on the next time the melter is switched on.

*Function Keys*

If a power failure occurs, the melter will restart in its normal heat-up cycle, even if the heaters were off or the melter was in standby prior to the power failure. If the seven-day clock was on prior to the power failure, the melter will restart in the mode dictated by the clock schedule at the time the melter restarts.

## Manually Adjusting the Pump Speed

When the motor control is set to manual operation, the pump speed can be adjusted from 0-94 rpm.

**NOTE:** When the motor control is set to automatic operation, pressing the motor speed arrow keys will alter the ratio of the line speed reference signal to allow for fine-tuning of the adhesive output rate.

### Adjust the Motor Speed for Manual Operation

**CAUTION!** To ensure adequate motor control and cooling, the recommended minimum pump speed is 18 rpm or greater. To prevent excessive wear on the pump, avoid prolonged operation of the pump at speeds greater than 80 rpm.

1. Use the following formula to determine the best pump speed:

$$\text{pump speed [rpm]} = \frac{\text{desired flow rate [g/min]}}{\text{adhesive density [g/cc]} \times \text{pump output rate [cc/rev]}}$$

2. Press the pump speed arrow keys to adjust the motor(s) to the desired speed (rpm). Each press of an arrow key increases/decreases the motor speed by 1 rpm.

The current motor speed is indicated on the display.

**NOTE:** You can change the amount by which the motor speed increases or decreases (1%, 1 rpm, 0.5 rpm, etc.) upon each press of an arrow key by changing the value of the motor control SEt parameter. Refer to *Changing a Motor Control Parameter* in Section 6, *Troubleshooting*.

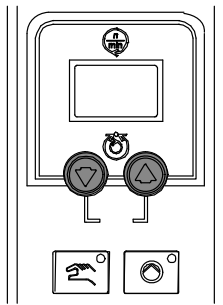

Pump speed arrow keys

## Adjusting Material Pressure

The pressure of each material stream can be independently adjusted from 0-103 bar (0-1500 psi).

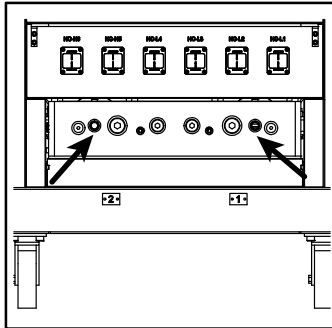

To adjust the pressure, loosen the set screw, and then turn the pressure adjustment screw clockwise. When the pressure adjustment is set to its full counterclockwise position, 100% of the material is re-circulated.

Pressure control valves

# Monitoring the Melter

The melter provides indicators that allow you to:

- Quickly confirm that the melter is operating correctly
- Monitor the actual temperature of the tank group and each hose and applicator
- Monitor the speed of the motor(s)
- Identify melter faults
- Determine when service is required

The melter automatically determines the number and receptacle of all hoses and applicators that are connected to it. Refer to *Heated Components*, earlier in this section, for information on identification of heated components.

## Confirm that the Melter is Operating Correctly

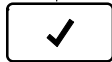
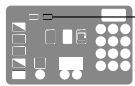

Ready LED

The ready LED turns on (green) when all of the heated components are within 3 °C (5 °F) of their set-point temperature.

The ready LED will not turn on, or will turn off, if any of the following events occur:

- The ready delay is still counting down.
- The operator or a remote input places the melter in the standby mode.
- The seven-day clock places the melter in the standby mode.
- There is a fault (the fault LED will turn on).

Refer to *Monitor Melter Faults* and *Using Function Keys* in this section for information about melter faults and using the seven-day clock and standby functions. Refer to Parameter 4 in Appendix B, *Operating Parameters*, for information about the ready delay.



Heated components with a set-point temperature of zero degrees are skipped during the automatic scan cycle.

The set-point temperature of the tank and the pump cannot be set independently.

The time remaining on the ready delay appears in the right display at the end of each scan cycle.

Appendix B, Parameter 4

You can override the seven-day clock at any time. If the clock has turned the heaters off, pressing the heaters key will turn the heaters back on. If the clock has placed the melter into the standby mode, pressing the standby key will return the heated components to their assigned set-point temperature.

Function Keys

## Monitor Component Temperatures

The actual temperature of each heated component—the tank and each hose and applicator—can be checked via normal mode or by manually selecting and checking each component.

By default, the melter remains in the automatic scan mode except when:

- The melter is placed into the setup mode
- The set-point temperature of all hoses and applicators is set to zero degrees
- A fault occurs

### To check component temperatures using the automatic scan mode

1. When the ready LED is on, observe the LEDs on the component keys.
2. When the LED on the key that represents the desired component group (tank, hose, or applicator) turns on, observe the left display until it indicates the position number of the specific component you want to check.
3. When the position number of the desired component appears in the left display, observe the right display to determine the component's actual temperature.

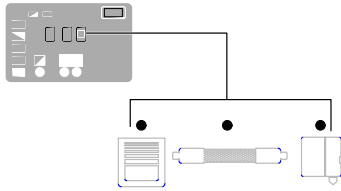

LEDs on component keys

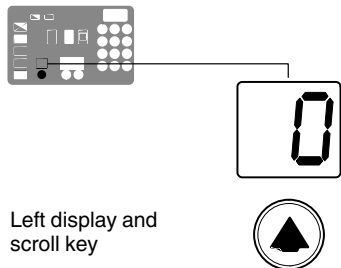

Left display and scroll key

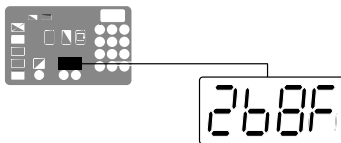

Component temperature display

### To manually check a component's temperature

1. Press the key (tank, hose, or applicator) that represents the component group you want to check.

The automatic scan stops and the left display indicates the number of the first sequential component in the selected component group. The right display indicates the component's actual temperature.

**NOTE:** When the tank key is pressed, the left display does not indicate a component number (blank display).

2. If the first sequential component is not the component you want to check, use the left-display scroll key to change to the correct component number.

The right display indicates the actual temperature of the selected component.

3. Press the **Setup** key twice to return to the automatic scan mode.

### To manually check a component's temperature (contd)



When you scroll the left display past the number of the last sequential component in a component group, the number of the first sequential component in the next component group appears in the left display.

---

The melter will return to the automatic scan mode two minutes after the last key is pressed.

---

When you press the **Tank** key, it is the pump temperature that is actually indicated in the right display. To check the actual temperature of the tank, simultaneously press the **Tank** key and the left-display scroll key.

---

The default unit for temperature display is degrees Celsius (C). This may be changed to degrees Fahrenheit using operating Parameter 20.

---

Appendix B, Parameter 20

The LEDs on each component key will change from green to yellow if any component in the component group drops more than 3 °C (5 °F) below its assigned set-point temperature.

---

You can check the set-point temperature of a component at any time, by pressing the right-display UP scroll key. Holding down the scroll key while the melter is in the automatic scan mode reveals the set-point of each component that is scanned.



## Monitor Melter Faults

The melter alerts the operator to the faults listed in Table 4-1.

When a fault occurs, you must diagnose and correct the fault condition and then place the melter back into operation. You can use the fault log to determine the type, order, and relative time of the last ten faults.

Table 4-1 Melter Faults

Display Code/Sub-code	Name	Affect on Melter	Cause	Corrective Action
F1/None	RTD	Heaters turn off	The RTD for the component indicated has failed or the component was disconnected from the melter.	Replace RTD Check hose/applicator connections
F2/None	Under temperature	Heaters turn off	The actual temperature of the component indicated has dropped below the under temperature delta, which was set using parameter 22.	Check for conditions that may cause a drop in ambient temperature Replace RTD
F3/None	Over temperature	Heaters turn off	The actual temperature of the component indicated has increased beyond the over temperature delta, which was set using parameter 21.	Replace RTD
F4/1	RAM test	Melter stops functioning	Internal RAM failure	Replace CPU
F4/2	Internal Clock time	Heaters remain on, but fault condition persists	Internal clock failure	Replace CPU
F4/3	RAM backup battery	Clock does not function	Insufficient voltage from RAM backup battery	Replace CPU
F4/4	Internal clock battery backed RAM	Heaters remain on, but fault condition persists	Battery-backed RAM failure	Replace CPU
F4/5	Internal clock battery	Heaters remain on, but fault condition persists	Battery-backed RAM battery dead	Replace CPU
F4/6	Analog-to-digital	Melter stops functioning	RTD analog-to-digital converter failed	Replace main board or CPU

*Continued...*

Table 4-1 Melter Faults (contd)

Display Code/Sub-code	Name	Affect on Melter	Cause	Corrective Action
F4/7	Analog-to-digital calibration	Melter stops functioning	Failed hose or applicator  RTD analog-to-digital converter could not be calibrated (grounded RTD in system)	Replace hose or applicator. Note: Set setpoint to zero to avoid F1 fault.  Replace main board or ribbon cable, or CPU
F4/8	Main board feedback	Melter stops functioning	Communication failure between main board and CPU	Replace main board, ribbon cable, or CPU
F4/9	Expansion board feedback	Melter stops functioning	Communication failure between expansion board and main board	Check the ribbon cable connections between the expansion board and the main board.
F4/A	Thermostat	Melter stops functioning	Tank or manifold thermostat is open	Replace thermostat, J7 harness, or main board
F4/d	Communications with optional I/O card	Heaters remain on, but fault condition persists	Communication failure between CPU and the optional I/O card	Replace the I/O card or CPU
F4/E	Fieldbus communications failure	Alert output (if output option 6 is selected) Melter continues to operate normally.	Fieldbus card failure.	Replace the Fieldbus card

### F1, F2 and F3 Faults

When the melter detects an F1, F2, or an F3 fault:

1. The automatic scan stops and the melter begins to monitor the potential fault for up to two minutes. The ready and heater LEDs remain on during the two-minute time period. If, at any time during the two-minute period, the melter detects that the fault condition no longer exists, the melter will return to the automatic scan mode.
2. The LED on the affected component key (tank, hose, or applicator) turns on to indicate the type of component that has, or is, failing.
3. The right display indicates the type of fault (F1, F2, or F3).

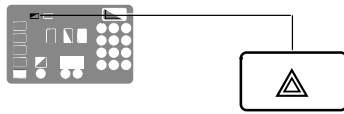

Fault LED (red)

4. The left display indicates, as follows, the component that has, or is, failing.
  - If the LED on the tank key is on, the left display will indicate either 1 for the tank or 2 for the pump.
  - If the LED on the hose or applicator key is on, the left display will indicate the number of the affected hose or applicator.
5. If the fault condition still exists at the end of the two-minute monitoring period, the ready LED will turn off, the red fault LED will turn on, the heaters turn off, and the melter records the fault in the fault log. Refer to *Monitor Melter Faults* in this section.

To be able to put the melter back into operation, the fault must be remedied and the melter reset (reset key). Refer to Section 6, *Troubleshooting*, for information about diagnosing and correcting fault conditions. Also refer to *Returning the Melter to Factory Settings*.



To view the temperature of a heated component when an F2 or F3 fault exists, simultaneously press and hold both of the right-display scroll keys.

You can temporarily dismiss an F1 fault (RTD) and return to the automatic scan mode by pressing the **Clear/Reset** key. The heaters will, however, remain off. If the fault condition still exists two minutes after pressing the clear/reset key, the fault LED will turn back on.

When an F1 fault code appears, you can determine whether the fault was caused by an open or a shorted RTD by simultaneously pressing both of the right-display scroll keys. If the right display indicates OP, the RTD is open, if it indicates SH, the RTD has shorted.

If, for any reason, a component reaches 235 °C (458 °F), an immediate F3 fault will occur (no two-minute monitoring period).

### F4 Fault

When the melter detects an F4 fault:

1. The ready LED turns off and the red fault LED turns on.
2. All of the component key LEDs (tank, hose, and applicator) turn off.
3. The right display indicates F4.
4. The left display indicates a sub-code. Sub-codes classify the fault as being fatal or nonfatal. The affect on the melter of each of these two classes of F4 faults is:

**Fatal**—The fault LED turns on and stays on and the melter stops functioning completely.

**Nonfatal**—The fault LED turns on for five seconds, but the heaters and pump continue to operate normally. Nonfatal faults affect the internal clock.

5. The melter records the fault in the fault log. Refer to *Monitor Melter Faults* in this section.

### Resetting the melter

1. Diagnose and correct the fault condition. Refer to Section 6, *Troubleshooting*, for information about diagnosing and correcting fault conditions.
2. Return the melter to the automatic scan mode by pressing the **Setup** key twice.
3. Press the **Clear/Reset** key.
4. Press the **Heater** key to turn on the heaters.

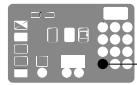

Clear/Reset key

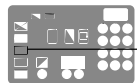

Heater key

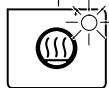

If F4 appears in the right display when you press the clock key, the internal clock function has failed.

### Reviewing the Fault Log

1. Press and hold the **Setup** key.

The automatic scan stops and operating Parameter 1 appears in the left display.

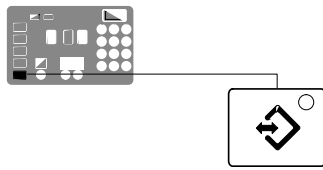

2. Scroll the left display to Parameter 2 (the fault log).

The right display indicates the last fault that occurred as follows:

- If the last fault was an F1, F2, or F3 fault, then the LED on the affected component key turns yellow.
- If the last fault to occur was an F4 fault, then the LEDs on all of the component keys turn off.
- The right display indicates the log entry for the last fault to occur. Table 4-2 provides the meaning of each digit in the log entry. Following the table are two example fault log entries.

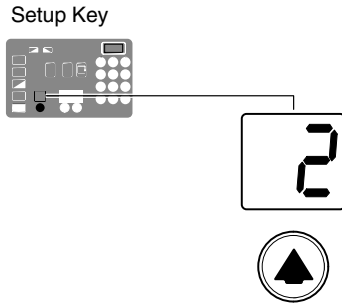

Left display and scroll key

3. Press the right-display scroll key to review each of the remaining nine log entries. Each press of the scroll key displays a progressively older log entry.

**NOTE:** The fault log only stores the last ten faults. After ten faults occur, the existing log entries are overwritten, beginning with the oldest entry, by the eleventh and following log entries.

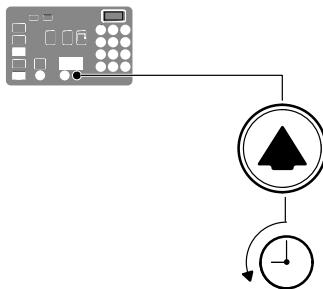

Scrolling through the fault log

4. Press the **Setup** key to return to the automatic scan mode.

Table 4-2 Fault Log

First Digit	Second and Third Digits	Fourth Digit
<p><i>Component:</i></p> <p>1 = Tank or hose/applicator 1                      2 = Pump or hose/applicator 2                      3 = Hose 3 or applicator 3                      4 = Hose 4 or applicator 4                      5 = Hose 5 or applicator 5                      6 = Hose 6 or applicator 6</p>	<p><b>- F</b></p>	<p><i>Type of fault:</i></p> <p>0 = Unused log entry                      1 = RTD (open or short)                      2 = Component under temperature                      3 = Component over temperature                      4 = Processor or electrical failure</p>

### Fault Log examples

Example 1:

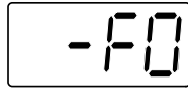

An unused log entry.

Example 2:

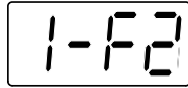

If the LED on the tank key were on, this log entry would indicate that the tank is under temperature. If the LED on the hose key were on, this log entry would indicate that hose 1 is under temperature.



To view the number of heater hours that have elapsed since a log entry was created, simultaneously press both of the right-display scroll keys. The hours are indicated in the right display.

---

The melter will return to the automatic scan mode if the fault log is left open for a period of two minutes without any key being pressed.

---

When an F1 fault is the result of a hose/applicator pair being disconnected from the melter, two fault log entries are created. The first entry is for the applicator and the second entry is for the hose.

## Monitor the Service Interval

The melter can be set up so that the service LED located on the left side of the control panel turns on after a customer-defined time period has elapsed. The service LED may be used to signal the need to change the hot melt filter or to complete any other customer-specified maintenance activity. Once the specified maintenance is performed, the service LED must be reset.

### To reset the service LED

With the melter in the scan mode, press the **Clear/Reset** key to turn off the service LED and reset the service interval time.

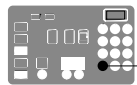

Clear/Reset key



The default setting for the service interval time is 500 hours, refer to Parameter 5 in Appendix B.

## Adjusting Component Temperatures

You can adjust the set-point temperature of heated components using the following methods:

- **Global**—The tank and all hoses and applicators are set to the same set-point temperature.
- **Global-by-component group**—All of the hoses or all of the applicators are set to the same set-point temperature.
- **Individual Component**—The set-point temperature of the tank and each hose and applicator is adjusted independently.

Before adjusting set-point temperatures, confirm that each hose/applicator pair is connected to the correct hose/applicator receptacle. For example, hose/applicator pair 1 should be connected to the receptacle 1. Refer to *Heated Components* earlier in this section for information about hose/applicator positions.

**NOTE:** For additional temperature control features, refer to Parameters 20-29 in Appendix B, *Operating Parameters*.

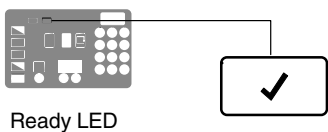
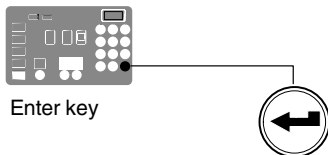
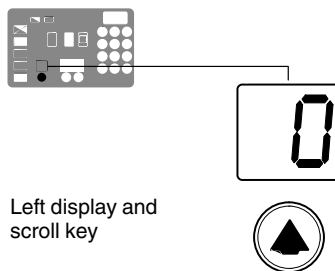
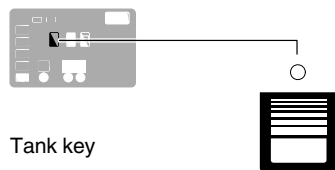

### To adjust the setpoint temperature using the global method

1. Press and hold the **Tank** key for three seconds.

The left display flashes 1.

2. Scroll the left display to 0 (flashing).

The right display indicates all dashes (----) and the LEDs on all of the component keys turn green.

3. Press the **Enter** key.

The right display flashes.

4. Use the keypad to enter the set-point temperature recommended by the manufacturer of the hot melt.

**NOTE:** If the keypad or the right-display scroll keys have no effect on the right display, the melter is password protected. You must enter a valid password before you can change set-point temperatures. Refer to *Entering a Password* in this section.

5. Press the **Tank** key.

All components begin to heat or cool to the new global set-point temperature. When all of the components reach their set-point temperature, the ready LED turns on (green).



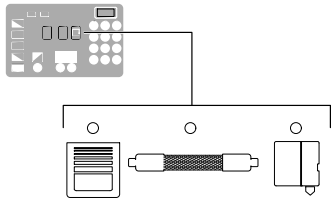

Tank, hose, and applicator keys

### To adjust the setpoint temperature using the global-by-component method

1. Press and hold the **Hose** or **Applicator** key for three seconds.

The left display indicates the number of the first sequential hose or applicator. The right display indicates the current set-point temperature of the hose or the applicator.

2. Scroll the left display to 0.

The right display indicates all dashes (- - -).

3. Press the **Enter** key.

The right display flashes.

4. Use the keypad to enter the set-point temperature recommended by the manufacturer of the hot melt.

**NOTE:** If the keypad or the right-display scroll keys have no effect on the right display, the melter is password protected. You must enter a valid password before you can change set-point temperatures. Refer to *Entering a Password* in this section.

5. Press the **Enter** key.

The hoses or the applicators begin to heat or cool to their new set-point temperature.

**To adjust the setpoint temperature of an individual component**

1. Press and hold the **Tank**, **Hose**, or **Applicator** key for three seconds.

If the tank key was pressed, the left display indicates 1 (Flashing). If a hose or applicator key was pressed, the left display indicates the number of the first sequential hose or applicator (Flashing). The right display indicates the current set-point temperature of the component indicated in the left display.

2. Scroll the left display to the number of the desired component.

The right display indicates the current set-point temperature of the component that you selected in the left display.

3. Press the **Enter** key.

The right display flashes.

4. Use the keypad to enter the set-point temperature recommended by the manufacturer of the hot melt. Refer to the technical data sheet provided by the manufacturer of the hot melt to determine the optimal set-point temperature.

**NOTE:** If the keypad or the right-display scroll keys have no effect on the right display, the melter is password protected. You must enter a valid password before you can change set-point temperatures. Refer to *Entering a Password* in this section.

5. Do *one* of the following:

- To register the new set-point temperature and then move on to change the set-point temperature of the next sequential component, press the **Enter** key and then repeat steps 4 and 5.
- To register the new set-point temperature and return to the automatic scan mode, go to step 6.

6. Press any component key (tank, hose, or applicator).

The selected component begins to heat or cool to its new set-point temperature.



If you enter a valid set-point temperature for a hose/applicator that is not connected to the melter or if you enter a set-point temperature that is out of range, the right display will indicate dashes (----) for three seconds and then change back to the original set-point temperature.

When the right display is flashing, you can quickly change the current set-point temperature to 0 degrees (off) by simultaneously pressing both of right-display scroll keys.

After removing a hose or a applicator, use the individual component method of set-point temperature adjustment to set the component's temperature to zero degrees (off). This will avoid causing an F1 fault. When a hose or applicator is added, use the individual component method to set the desired temperature.

The factory set-point temperature of the tank is 175 °C (350 °F). The factory set-point temperature of all others components is zero degrees (off).

When the units of temperature is set to degrees Celsius, the minimum and maximum set-point temperatures are 40 °C and 230 °C. When the units of temperature are set to degrees Fahrenheit, the minimum and maximum set-point temperatures are 100 °F and 450 °F.

When using the right-display scroll keys to adjust a set-point temperature, the right display automatically increments between 0, 175, and 230 °C or between 0, 350, and 450 °F.

If you make a mistake while you are changing a set-point temperature, but you have not yet pressed the enter key, press the **Clear/Reset** key to reset the right display to the original temperature.

The melter will exit the setup mode and return to the automatic scan mode two minutes after the last key is pressed.

A global set-point temperature of zero degrees (Celsius or Fahrenheit) turns all components off.

When scrolling through component numbers in the left display, component numbers that are associated with unused hose/applicator receptacles are skipped.

The melter stores a record of the last ten changes made to the set-point temperatures (and operating parameters) in the change history log.

Section 3, *Installation, Review Parameter and Set-point Temperature Changes*

You can save set-point temperature changes by simultaneously pressing the **1** key and the **Setup** key.

Section 3, *Installation, Save and Restore Melter Setting*

## Entering a Password

If the melter is password protected, a valid password must be entered before any set-point temperature or melter parameter can be changed.

### To enter a melter password

1. Press the **Setup** key.

The left display indicates Parameter 0 (flashing) and the right display indicates 4000.

2. Press the **Enter** key.

The right display begins flashing.

3. Use the keypad to enter the melter password.

4. Press the **Enter** key.

One of the following occurs:

- If the password is correct, the left display indicates Parameter 1.
- If the password is incorrect, the left display remains at 0 and the right display momentarily indicates dashes (----) and then returns to 4000.

If the password is incorrect, re-enter it and then press the **Enter** key.



The melter will automatically revert back to the password-protected mode two minutes after the last key press (any key). To force the melter back into the password protected mode before two minutes has elapsed, press the **Setup** key twice.

---

The melter password is created and enabled/disabled during system setup.

*Setting Up the Melter* in Section 3, *Installation*

# Using Function Keys

The control panel provides the following standard and special function keys:

### Standard function keys

- Heater
- Pump (1 and 2)
- Setup

### Special function keys

- Seven-day clock
- Standby



**CAUTION!** Unintentionally activating function keys can, under the correct circumstances, have undesirable effects on the melter or the manufacturing process. Only personnel who are familiar with the melter's setup and its connection with the manufacturing process should use the function keys. Improper use of the function keys can result in erratic process behavior or personal injury.

## Heater Key

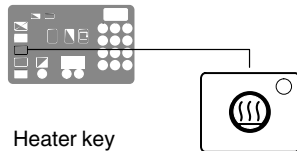

Heater key

Use the heater key to manually turn the component heaters on and off. Pressing the heater key overrides the control (on or off) of the heaters by either the seven-day clock feature or a remote input. The LED on the heater key illuminates when the heaters are on.

When a fault occurs (refer to *Monitor Melter Faults* in this section) the heaters automatically turn off. The heater key is used to turn the heaters back on after correcting a fault condition.

## Master Pump Enable Key

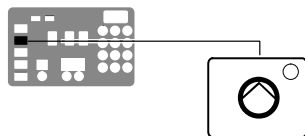

Master pump enable key/LED

Use the master pump enable key to enable and stop the pumps. The LED is green when the pumps are enabled and the melter is ready.

If the automatic pump on feature (Parameter 8) is disabled, then the master pump enable key must be used to start the pumps when the melter is ready.

If any of the inputs are set up to use the pump enable/disable control option, the pump motor will not start until the pump is enabled *and* the correct voltage is applied to the input contacts. If the pump is enabled, but the input voltage is not present, the master pump enable key LED will flash green.

## Setup Key

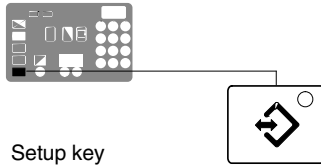

Setup key

Use the setup key to place the melter into and take the melter out of the setup mode. When the melter is placed into the setup mode, the automatic scan stops and the left and right displays are used to select and read or edit operating parameters.

## Seven-Day Clock Key

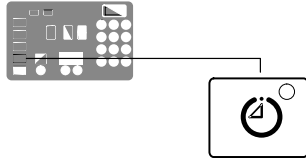

Seven-day clock key

Use the seven-day clock key to turn the melter's clock feature on and off. When the clock is on, the temperature of each heated component is automatically regulated based on a set of user-defined schedules.

To accommodate daily shift work and non-working days, four clock schedules are available. Schedules 1, 2, and 3 are used to specify when the heaters should turn on and off or when the melter should enter and exit the standby mode. Schedule 0 is used to keep the melter in the last condition dictated by the clock (heaters on or off, or standby).

When a clock schedule calls for the heaters to be on, the heaters are regulated at their pre-assigned set-point temperatures. When the clock activates the standby mode, the set-point temperature of each component is temporarily reduced by a pre-set standby delta.

Refer to Appendix B, *Operating Parameters*, for information about setting up the seven-day clock and the standby delta.



If the melter is switched off while the clock is on, the clock will automatically turn back on the next time the melter is switched back on.

If the heaters are manually turned off at the time that a clock schedule calls for the heaters to be on, the heaters will not turn back on until the next clock schedule calls for them to be on.

The clock will still operate when the melter is faulting or is in the setup mode.

If F4 appears in the right display when you press the clock key, the internal clock function has failed.

Section 7, *Troubleshooting*

## Standby Key

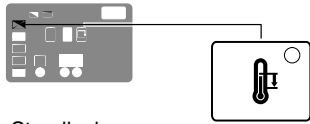

Standby key

Use the standby key to manually place the melter into, and take it out of, the standby mode. Using the standby mode during periods of time when the melter is inactive helps conserve energy and allows heated components to quickly return to their set-point temperatures when the melter is once again needed.

When the melter is placed into the standby mode, the temperatures of all components are reduced down from their set-point temperature by a pre-set standby delta. The melter will remain in the standby mode until the standby key is pressed or the function of one of the operating parameters takes the melter out of the standby mode.

If the melter was set up to use the manual standby timer (Parameter 26), pressing the standby key will place the melter in the standby mode for the period of time specified by the timer. After the manual standby time has elapsed, the melter will once again begin heating all of the components to their assigned set-point temperature.

Using the standby key overrides the control of the melter (on or off) by the seven-day clock or a remote input.

Refer to Section 3, *Installation, Setting Up the Melter*, and to Appendix B, *Operating Parameters*, for information about setting the standby delta and the standby timer.



The melter may also be set up to automatically enter the standby mode using a variety of operating parameters.

Appendix B, Parameters 25, 26, 57, 30-33, 62, and 67

Whenever manual standby is enabled, the standby LED blinks. Appendix B, Parameter 26

## ***Shutting Down the Melter***

Shut the melter down when it will not be used for an extended period of time.

### **To shut the melter down**

1. Press the pump enable key(s) to disable the motor(s).
2. Place the control switch in the OFF position.
3. Place the main power switch in the OFF position.
4. Disable the applicators as follows:
  - Air-operated applicators: turn off the air supply to the applicators.
  - Electric applicators: turn off the applicator driver, pattern controller, or timer.



# Record of Melter Settings

<b>Production information:</b>
--------------------------------

<b>Material:</b>	Manufacturer
	Processing Temperature
	Viscosity

<b>Cleaning agent:</b>	Manufacturer
	Flash point

<b>Processing temperatures (Setpoint temperatures):</b>						
Tank/Grid/Reservoir						
Hose	1)	2)	3)	4)	5)	6)
Applicator	1)	2)	3)	4)	5)	6)

<b>Pump speeds:</b>		
Pump	1)	2)

<b>Notes:</b>
---------------

<b>Name</b>	<b>Date</b>
-------------	-------------

This page intentionally left blank.

## Section 5

# Service



**WARNING!** Allow only qualified personnel to perform the following tasks. Follow the safety instructions in this document and all other related documentation.

Maintenance is an important preventive measure for maintaining operating safety and extending the lifetime of the unit. It should not be neglected under any circumstances.

## ***Relieving System Pressure***



**WARNING!** System and material pressurized. Relieve system of pressure before disconnecting hoses, applicators and hot melt hand-held applicator. Failure to observe can result in serious burns.

### **Through the Applicators**

1. Disable the motor(s). Refer to Section 4, *Operation*.
2. Place a container under the nozzle(s) of the applicator/assembly hand-held applicator.
3. Activate the solenoid valve(s) electrically or manually; or, pull the trigger of the assembly hand-held applicator. Repeat this procedure until no more material flows out.
4. Re-use the material or properly dispose of it according to local regulations.

## Through the Melter Drain Valves

1. Disable the motor(s). Refer to Section 4, *Operation*.
2. Place a container under the drain valve ports located on the bottom of the manifold.
3. Open all the drain valves. Adhesive will drain from the valves.
4. When adhesive stops draining, close the drain valves.
5. Re-use the material or properly dispose it of according to local regulations.

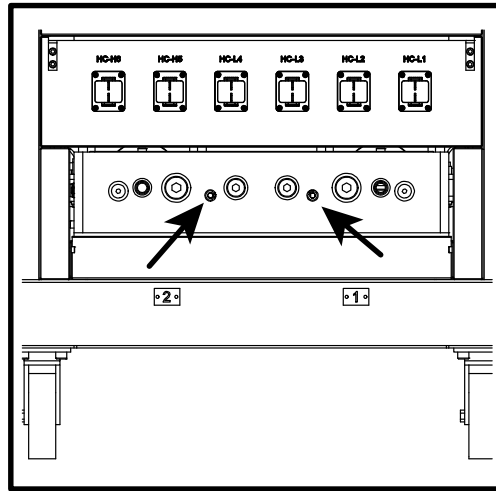

Figure 5-1 Location of the melter drain valves

## Preventive Maintenance Schedule

The maintenance intervals are general guidelines based on experience. Depending on the operating environment, production conditions and melter hours of operation, other scheduled maintenance tasks may prove necessary.

Melter part	Activity	Interval	Refer To
Complete melter	External cleaning	Daily	<i>External Cleaning</i>
	Inspect for external damage	Daily	
	Purge with cleaning agent	When material is changed	<i>Changing the Material Type</i>
Fan and air filter	Check filter, clean or replace if necessary Clean fan screen	Depending on dust accumulation; daily if necessary	<i>Fan and Air Filter</i>
Power cable	Inspect for damage	Every time the melter is serviced	
Air hoses	Inspect for damage	Every time the melter is serviced	
Pump	Tighten the gland bolt (if present)	After initial startup	<i>Pump</i>
	Check for leakage, tighten gland bolt (if present) if necessary	Dependent on hours of operation, pump speed and pump temperature Recommendation: Monthly	
	Tighten fixing screws	Every 500 hours of operation	
Motor / gear box / coupling	Clean fan cover	Depending on dust accumulation; daily if necessary	<i>Motor and Gear Box</i>
	Change lubricant	Every 15000 hours of operation or every 2 to 3 years	
Pressure control valve	Disassemble and clean	Every six months	<i>Pressure Control Valve</i>
Filter cartridge	Replace filter cartridge Disassemble and clean filter cartridge	Depending on degree of material pollution Recommendation: Every 1000 hours of operation	<i>Filter Cartridge</i>
Tank	Clean tank by hand	When there is material residue in tank	<i>Cleaning the Tank</i>
	Tighten fixing screws	Every 500 hours of operation	

## ***Changing the Material Type***

1. Run the melter until empty.
2. Determine whether the new material may be mixed with the old material.
  - May be mixed: Remaining old material can be flushed out using the new material.
  - May not be mixed: Thoroughly purge the unit with a cleaning agent recommended by the material supplier.

**NOTE:** Properly dispose of the old material according to local regulations.

## ***Detaching the Exterior Panels***

Open the protective panels with a 4 mm Allen key.

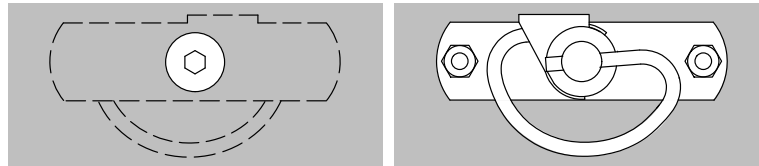

*On the inside*

## ***Fan and Air Filter***

The air filters must be cleaned (knocked out) or replaced, depending on dust accumulation.

Refer to Section 7, *Parts*, for the filter part number.

# Motor and Gear Box

## Changing the Motor Lubricant

Remove the gear motor assembly from the melter.

- Use only the stated lubricant or one that has proven to be equivalent (refer to *Lubricant Selection*). Using any other lubricant can result in premature wear and/or damage to the gear box.
- Drain lubricant when warm.
- Properly dispose of the old lubricant according to local regulations.

**CAUTION!** Never mix different types of lubricants.

### Lubricant Changing Interval

Operating temperature < 100 °C / 212 °F:

Every 15000 hours of operation or at least every 4 years.

### Lubricant Capacity

Ensure that the upper gears and rolling bearings are properly lubricated.

### Lubricant Selection

Lubricant manufacturer	Mineral oil CLP 220
AGIP	Blasia 220
ARAL	Degol BMB 220 or Degol BG 220
BP	Energol GR-XP 220
DEA	Falcon CLP 220
ESSO	Spartan EP 220 or GP 90
KLÜBER	Klüberoil GEM 1-220
OPTIMOL	Optigear 220
SHELL	Omala Oil 220
TEXACO	Geartex EP-A SAE 85 W-90

## Replacing a Motor or Coupling

Follow this procedure to replace a motor or coupling. You will need the following items:

- appropriate tools
  - replacement motor or coupling
  - anti-seize lubricant (if needed)
1. Disconnect and lock out electrical power to the melter.
  2. Remove the hydraulic side covers and the left and right control cabinet side covers. Refer to *Detaching the Exterior Panels* earlier in this section as needed.
  3. Disconnect the motor cable wires, noting their terminal positions.
  4. See Figure 5-2. Loosen the screws that secure the motor to the base of the melter and then slide the motor back.
  5. Slide the coupling sleeve (2) off of the coupling hubs (1 and 3), loosen the hub set screws, and remove the hubs.



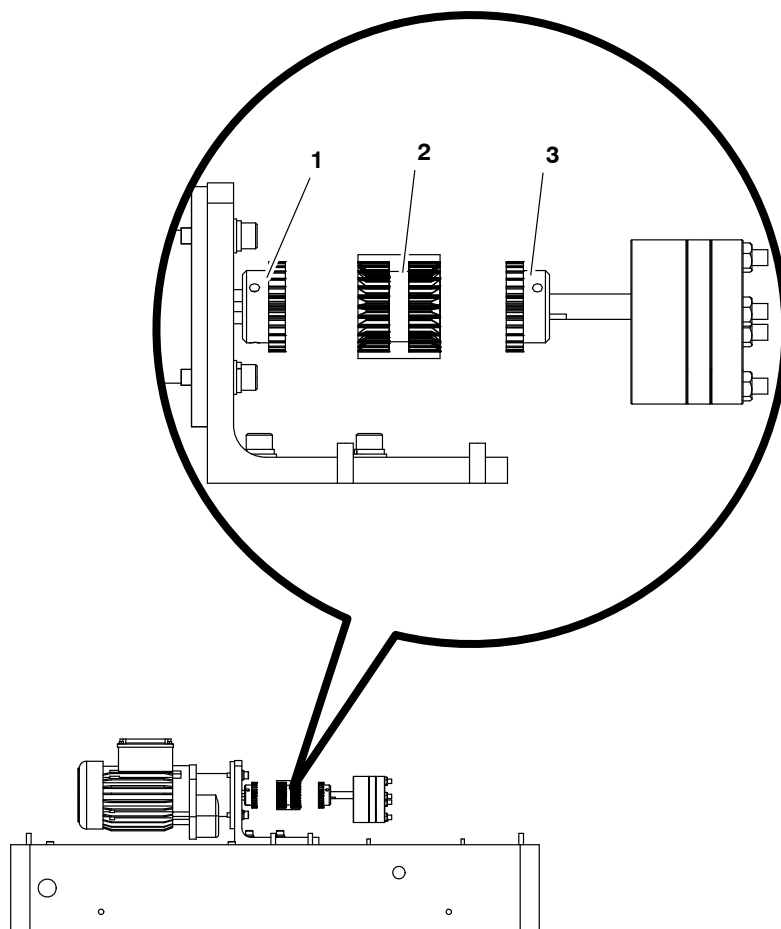

Figure 5-2 Coupling assembly components

- |                      |                     |
|----------------------|---------------------|
| 1 Motor coupling hub | 3 Pump coupling hub |
| 2 Coupling sleeve    |                     |

6. Remove the protective coating from the new motor shaft, slide the replacement (if applicable) motor coupling hub onto the motor shaft, and tighten the hub set screws.
7. Install the replacement (if applicable) pump coupling hub on the pump shaft, ensure that it is flush with the pump shaft, and tighten the hub set screws.
8. Loosely install the replacement motor assembly and slide the assembly, including the motor coupling hub and sleeve, toward the pump until the coupling sleeve engages with pump coupling hub.
9. Ensure that the coupling sleeve cannot move, then slide the motor assembly back 4 mm (0.16 in.), as indicated in Figure 5-3.

## Replacing a Motor or Coupling (contd)

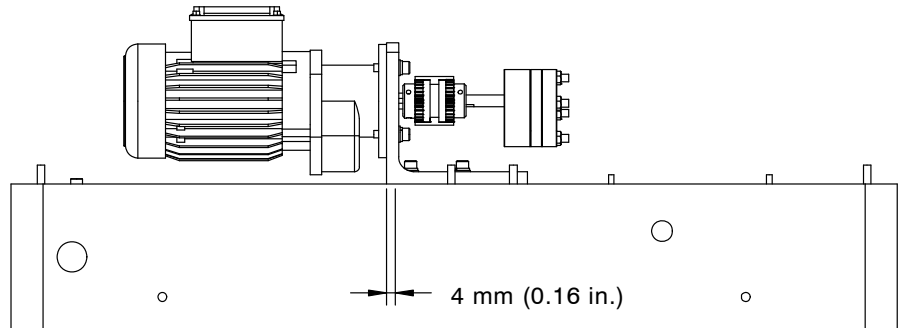

Figure 5-3 Moving the motor assembly back 4 mm (0.16 in.)

10. Tighten the screws that secure the motor to the base of the melter
11. To ensure proper motor and pump shaft alignment, ensure that you can freely slide the coupling sleeve back and forth by about 4 mm (0.16 in.) each way.
12. Reconnect the motor cable wires to the same terminals from which they were disconnected.
13. Reinstall the melter covers and restore the system to normal operation.

## Pump

### Tightening the Pump Screws

1. Ensure that the melter is turned off and that power has been disconnected and locked out.
2. Ensure that the melter, tank, manifold, and pump are cold.
3. See Figure 5-4. Tighten the screws to 25 N•m (222 in.-lb).

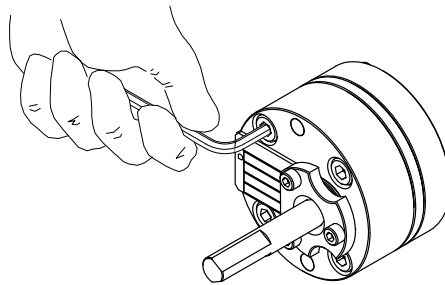

Figure 5-4 Tightening the pump screws

4. Restore the system to normal operation.

## Replacing a Pump

Follow this procedure to replace a pump. You will need the following items:

- tool kit, including a torque wrench
- drain pan
- cleaning supplies
- replacement pump
- replacement pump O-rings
- O-ring lubricant
- anti-seize lubricant

**NOTE:** To rebuild a pump, contact your Nordson representative for assistance.

1. Ensure the melter is at operating temperature.
2. Relieve system pressure. Refer to Section 1, *Safety*.
3. See Figure 5-5. Close the tank isolation valve.

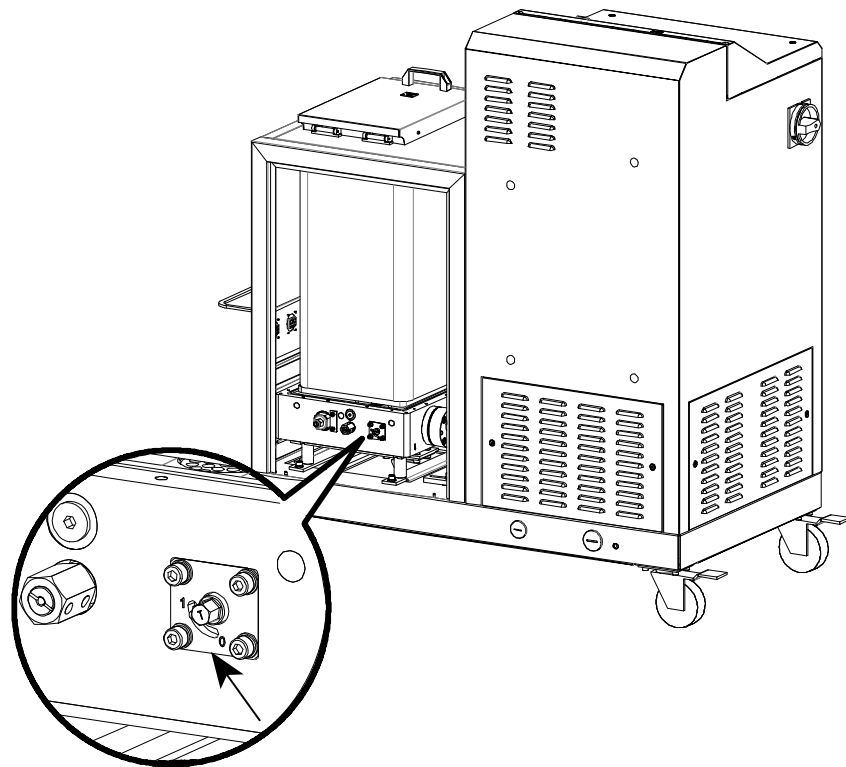

Figure 5-5 Location of the tank isolation valve

## Replacing a Pump (contd)

4. Remove the hydraulic side covers. Refer to *Detaching the Exterior Panels* earlier in this section as needed.
5. Place a drain pan under the pump.
6. See Figure 5-6. Loosen the screws that secure the motor to the base of the melter and then slide the motor back.
7. Slide the coupling sleeve (2) off of the coupling hubs (1 and 3), loosen the pump coupling hub set screws, and remove the pump coupling hub.

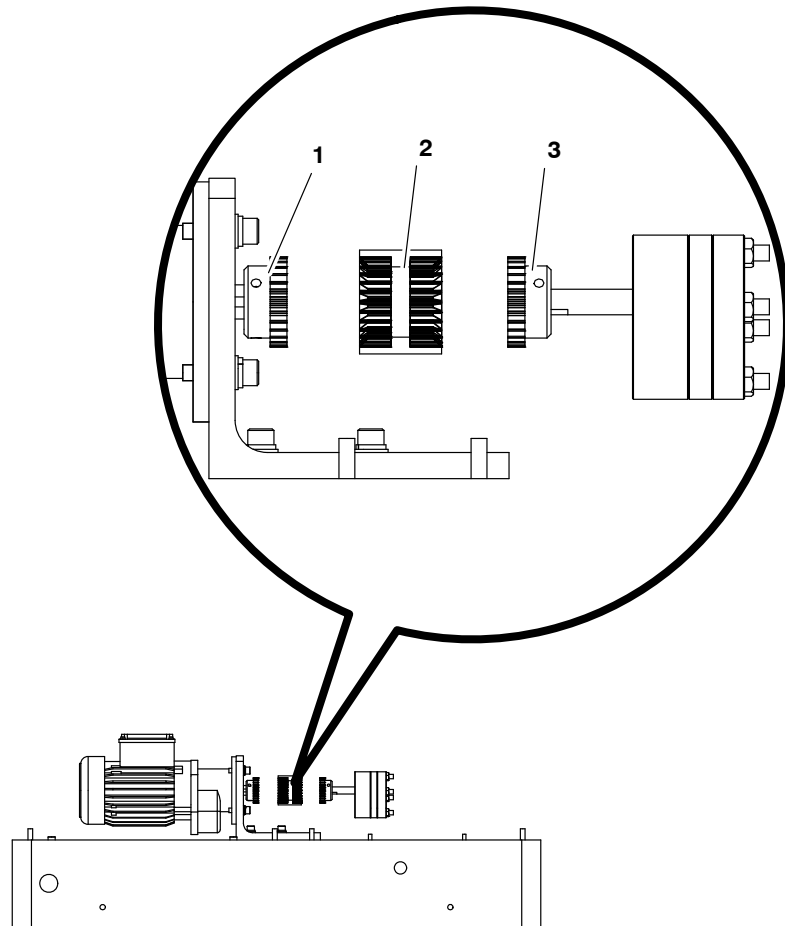

Figure 5-6 Coupling assembly components

- 1 Motor coupling hub
- 2 Coupling sleeve

- 3 Pump coupling hub

8. See Figure 5-7. Remove the pump screws (3) and then remove the pump (2) and O-rings (1).

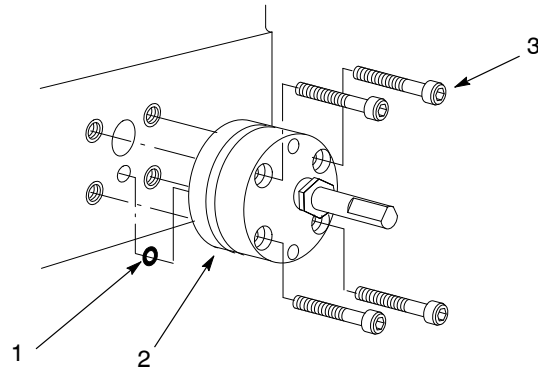

Figure 5-7 Replacing a pump

1 O-rings

2 Pump

3 Pump screw

9. Clean the surface of the manifold where the pump mates to it.
10. Allow the melter to cool to room temperature.
11. Install the pump coupling hub on the pump shaft, ensure that it is flush with the pump shaft, and tighten the hub set screws.
12. Apply O-ring lubricant to new pump O-rings and install them on the pump.
13. Apply anti-seize lubricant to the pump screws and secure the new pump to the manifold with the screws. Use a torque wrench to tighten the screws in a criss-cross manner to 25 N•m (222 in.-lb).

## Replacing a Pump (contd)

14. Slide motor assembly, including the motor coupling hub and sleeve, toward the pump until the coupling sleeve engages with pump coupling hub.
15. Ensure that the coupling sleeve cannot move, then slide the motor assembly back 4 mm (0.16 in.), as indicated in Figure 5-8.

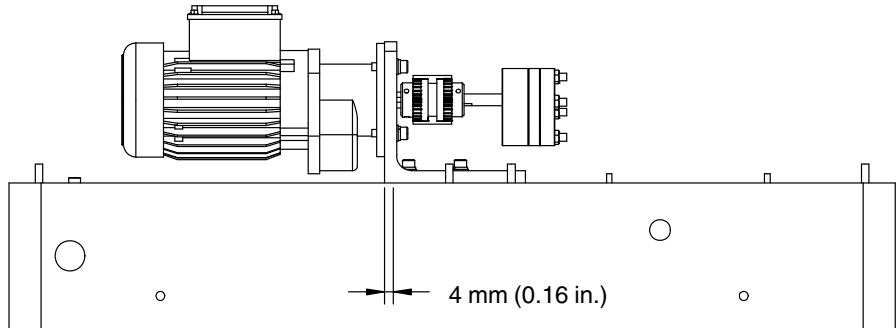

Figure 5-8 Moving the motor assembly back 4 mm (0.16 in.)

16. Tighten the screws that secure the motor to the base of the melter.
17. To ensure proper motor and pump shaft alignment, verify that you can freely slide the coupling sleeve back and forth by about 4 mm (0.16 in.) each way.
18. Restore the system to normal operation.

## Replacing the Adhesive Filter

DuraBlue II melters are equipped with a 100-mesh (0.15-mm) disposable hot melt adhesive filter. The adhesive filter removes debris and char from the hot melt as it flows from the tank. Hot melt flows from the inside to the outside of the filter, trapping contaminants inside the filter. There is no need to back-flush or clean the filter.

When the filter reaches the end of its service life, it should be replaced. The factors that determine the service life of the filter are:

- the type, grade, and purity of the solid-form hot melt
- the set point temperature of the tank
- the period of time that the hot melt remains in the tank

The filter should also be replaced when making the change to a different type or grade of hot melt.

To determine the optimal service life for the filter, monitor and compare the total number of hours that the heaters are on with observations of:

- the purity of the dispensed hot melt
- increases in operating pressure
- the frequency of applicator nozzle replacement or cleaning

As an aid to ensuring that the filter is replaced at the end of its service life, the melter is equipped with a service LED that turns on at the end of a customer-defined time period. Refer to *Setting Up the Melter* in Section 3, *Installation*, for information about the service interval time.

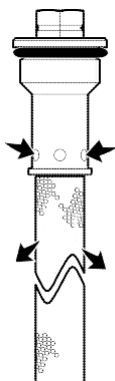

Hot melt flow path

### ***Replace the Adhesive Filter***

1. Relieve the system pressure. Refer to *Relieving System Pressure* at the beginning of this section.
2. Use an 8 mm ( $\frac{5}{16}$ -inch) hex-head wrench or an adjustable wrench to loosen (counterclockwise) and then remove the adhesive filter.
3. Properly dispose of the old filter.
4. Confirm that the O-ring on the new adhesive filter is in good condition (100-mesh filter is P/N 1028305).

**NOTE:** 50- and 150-mesh filters are also available (P/Ns 1021941 and 1034720).

5. Screw the filter into the pump body and then tighten the filter to 4.5 N•m (40 in.-lb).
6. Resume normal operation.

Service Kit, for P/N refer to Section 7, *Parts*.

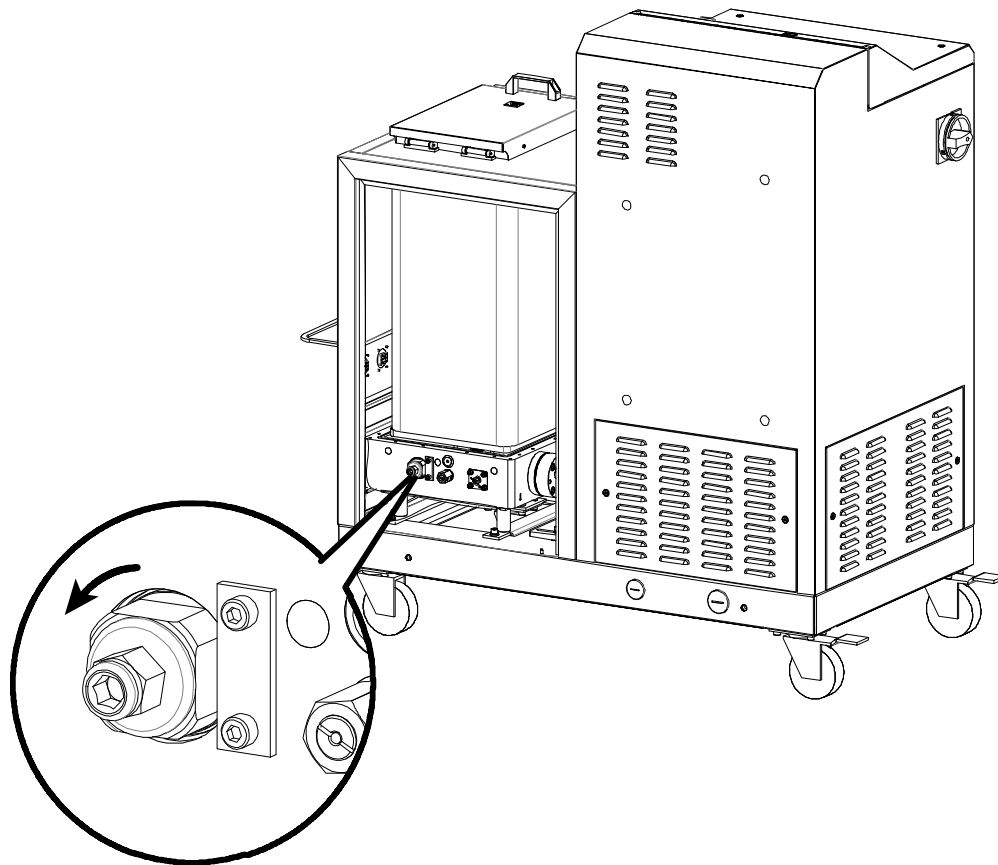

Figure 5-9 Turning the adhesive filter counterclockwise to remove



# Pressure Control Valve

## Replace the Pressure Control Valve

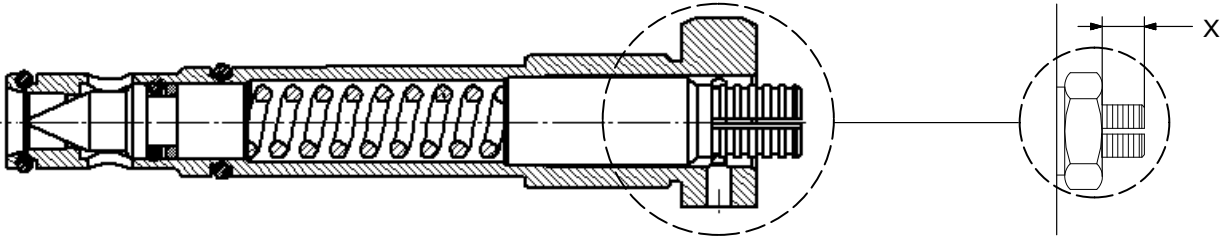
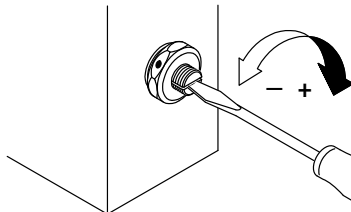

Figure 5-10 Pressure control valve set screw insertion depth

**NOTE:** Screw in only when valve and pump are warm and material is soft.



1. Ensure the melter is at operating temperature.
2. Relieve system pressure. Refer to Section 1, *Safety*.
3. Measure and make a note of the insertion depth of the set screw (dimension X). This way the insertion depth can be replicated after reassembly.
4. To prevent adhesive from leaking into the valve bore, drain the tank. Refer to *Draining Material from the Tank* later in this section as needed.
5. Remove the old pressure control valve.
6. Apply high temperature grease to all threads and O-rings.
7. Slide the valve into the hole and tighten with torque wrench (15 N•m / 133 in.-lb).
8. Adjust the setting screw to the recorded dimension X.
  - Turning to the right increases material pressure.
  - Turning to the left decreases material pressure.



Adjusting the set screw

## Pressure/Circulation Control Valve Service Kit

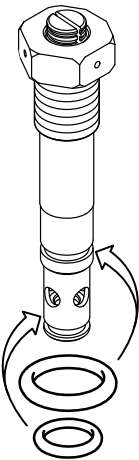
Each kit contains two O-rings and high-temperature grease.

Service kit P/N: 394600	
<b>Required tools:</b> Open-jawed wrench, size 24 Pliers Torque wrench	
	1. Heat melter to operating temperature.
	 <b>WARNING:</b> Hot! Risk of burns. Wear appropriate protective clothing/equipment.
	2. Relieve melter pressure.
	3. Measure insertion depth. Refer to <i>Pressure Control Valve</i> .
	4. Use an open-jawed wrench to screw out the pressure control valve, then extract with a pliers.
	5. Remove old O-rings and disassemble and clean pressure control valve. Refer to Section 7, <i>Parts</i> , for a detailed drawing.
	<b>NOTE:</b> Disassemble valve only when warm.
	6. Install new O-rings. Apply grease to all threads and O-rings.
7. Guide pressure control valve into the hole when the melter is warm and tighten with torque wrench. Starting torque: 15 N•m (133 in.-lb)	
8. Adjust set screw. Refer to <i>Pressure Control Valve</i> .	

# Cleaning the Tank

## Draining Material from the Tank

Pump material out of the melter.

**CAUTION!** Do not feed charred material through the applicator. Particles can block the applicator. Instead unscrew hose (refer to Section 3, *Installation*).

## Cleaning the Tank by Hand

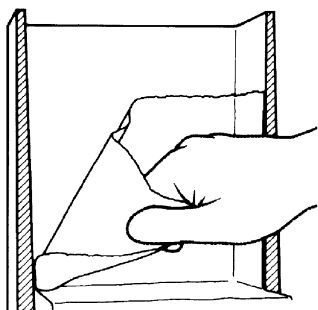

Cold material can usually be peeled off of the sides of the tank. If necessary, first heat tank to material softening temperature, usually approximately 70 °C / 158 °F.

**NOTE:** The inside of the tank is release coated. Do not use metallic tools to clean. Do not use wire brushes! This could damage the release coating.

## Tightening the Fixing Screws



Heating and cooling that occurs during daily operation can cause the fixing screws to loosen. Tighten screws as indicated in the table below.

**NOTE:** Tighten fixing screws only using a torque wrench and when the melter is cold.

Connection	Thread	Torque
Tank/manifold	M 6	6-8 N•m / 53-71 in.-lb

# Main PCA Board

## Replace the Main PCA Board

1. Disconnect power to the melter at the local disconnect switch.
2. Switch the melter off.
3. See Figure 5-11. Open the electrical enclosure access panel and locate the main PCA board.

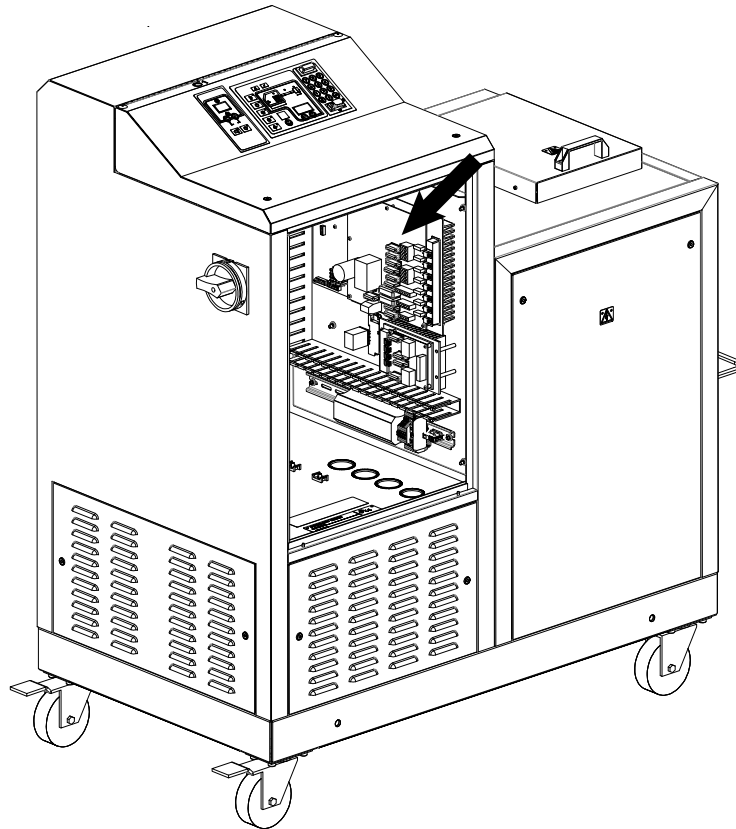

Figure 5-11 Location of the main PCA board

4. Disconnect all of the power and control cables from the board.
5. Remove the four fastening screws that hold the board on the mounting studs and then remove the board.

**NOTE:** Before installing the new board, you must ensure that the board is properly configured for the type of temperature sensors present on the melter. If the melter uses 100-ohm platinum sensors, the jumpers connected to the JP1 terminal on the old board must be removed and then installed on the new board. Figure 5-12 shows the location of terminal JP1 on the main PCA board. Figures 5-13 and 5-14 show the jumpers installed and not installed, as appropriate for each type of melter.

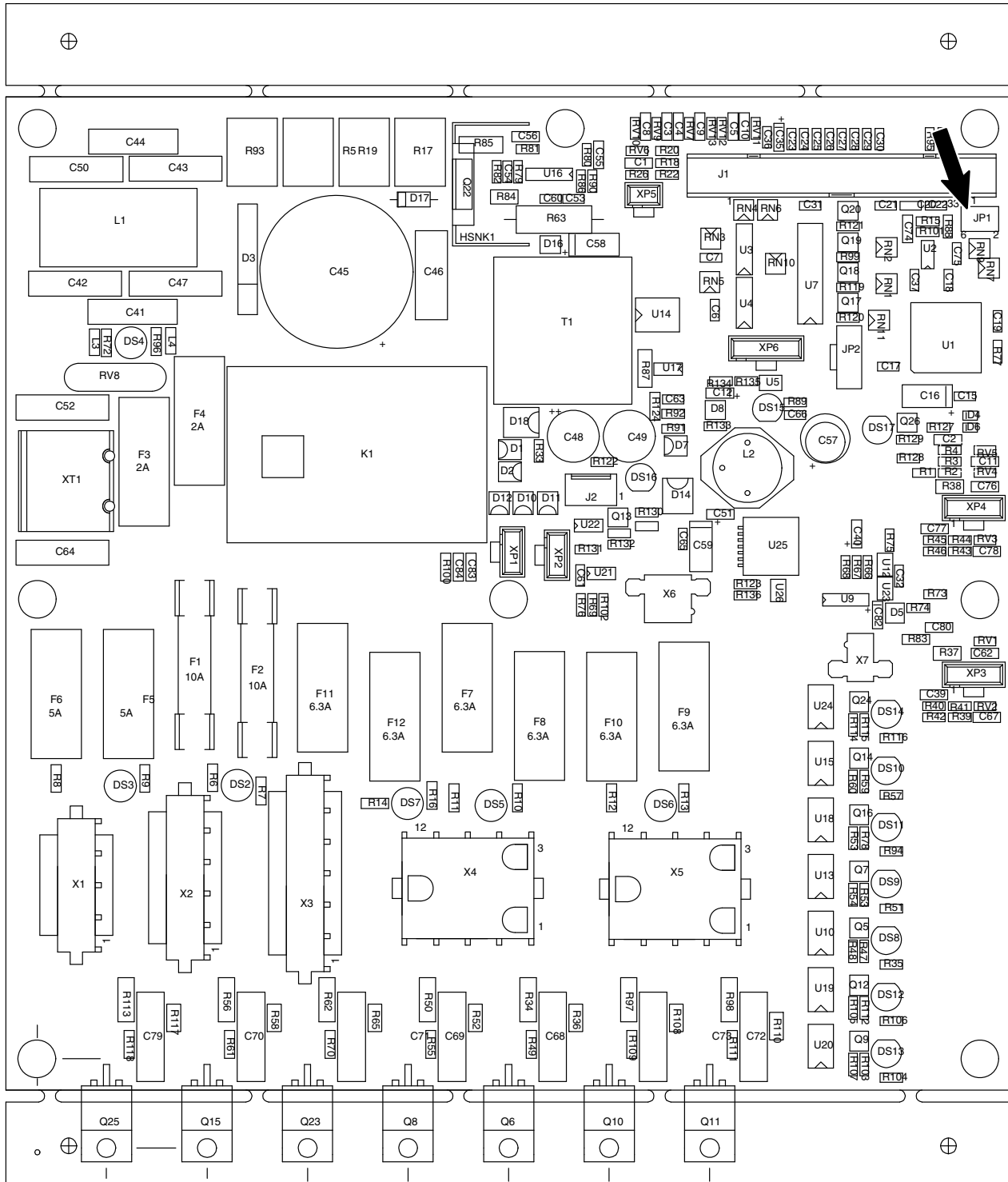

Figure 5-12 Location of the JP1 terminal on the main PCA board

## Replace the Main PCA Board *(contd)*

6. If 100-ohm platinum sensors are present on the melter:
  - a. Locate the JP1 terminal on the replacement board.

**NOTE:** For 120-ohm nickel melters, temperature sensor jumpers are not required in this location, as shown in Figure 5-14.
  - b. Install one of the jumpers removed from the old board between terminals 1 and 2.
  - c. Install the second jumper between terminals 5 and 6. Figure 5-13 shows the jumpers installed.

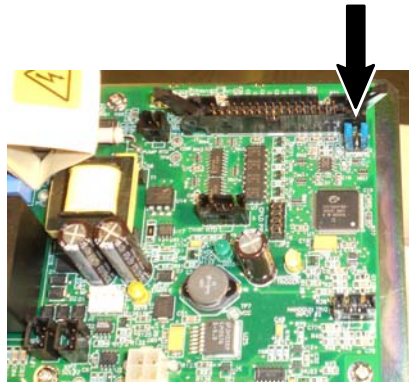

Figure 5-13 100-ohm platinum melter—jumpers installed

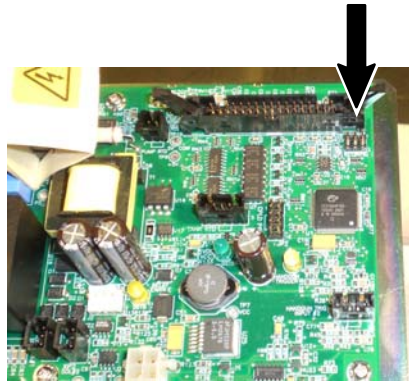

Figure 5-14 120-ohm nickel melter—no jumpers installed

7. Install the replacement board inside the melter electrical enclosure using the fastening screws removed previously.
8. Reconnect all of the power and control cables to the replacement board and close the electrical access panel.
9. Restore power to the melter and switch the melter on. Verify that the melter starts normally.

# Maintenance Record Form

Melter part	Date / Name	Date / Name	Date / Name
Pump			
Motor / gear box			
Fixing screws on pump and tank			
Air filter			
Tank			
Pressure control valve			
Filter cartridge			





## Section 6

# Troubleshooting



**WARNING!** Allow only qualified personnel to perform the following tasks. Follow the safety instructions in this document and all other related documentation.



**WARNING!** Troubleshooting activities may sometimes have to be carried out when the melter is energized. Observe all safety instructions and regulations concerning energized unit components (active parts). Failure to observe may result in an electric shock.

## Safety

- Never disconnect cables from, or reconnect cables to, the main board while the melter is energized.
- Before breaking any hydraulic connection, always relieve system pressure. Refer to *Relieving System Pressure* in Section 5, *Service*.
- Refer to the safety information provided with optional equipment.
- If the melter is removed from its sub-base for diagnostic checks or service, ensure that the ground lead between the chassis and the sub-base is re-attached when the melter is reconnected to the sub-base.

## ***Troubleshooting Quick-Checks***

Before using the troubleshooting charts confirm:

- whether or not service was recently performed on the melter or the melter's settings were recently adjusted.
- external inputs (if used) are functioning properly.
- the standby or clock functions are not turned on (if not required or expected at the current time).

## ***Returning the Melter Setup to Factory Settings***

By returning the melter to its factory setting many common melter problems can be isolated to either a problem with the melter settings or the melter hardware.

To return the melter to its factory settings, simultaneously press and hold the Setup key and the right-display DOWN arrow key, and then, while holding down these keys, cycle the control switch off and on. When the melter restarts, release the two keys.

# Melter Faults

Table 6-1 lists the four types of melter faults, potential causes, and expected corrective actions.

Table 6-1 Melter Faults

Display Code/Sub-code	Name	Affect on Melter	Cause	Corrective Action
F1/None	RTD	Heaters turn off	The RTD for the component indicated has failed or the component was disconnected from the melter.	Replace RTD Check hose/gun connections
F2/None	Under temperature	Heaters turn off	The actual temperature of the component indicated has dropped below the under temperature delta, which was set using parameter 22.	Check for conditions that may cause a drop in ambient temperature Replace RTD
F3/None	Over temperature	Heaters turn off	The actual temperature of the component indicated has increased beyond the over temperature delta, which was set using parameter 21.	Replace RTD
F4/1	RAM test	Melter stops functioning	Internal RAM failure	Replace CPU
F4/2	Internal Clock time	Heaters remain on, but fault condition persists	Internal clock failure	Replace CPU
F4/3	RAM backup battery	Clock does not function	Insufficient voltage from RAM backup battery	Replace CPU
F4/4	Internal clock battery backed RAM	Heaters remain on, but fault condition persists	Battery-backed RAM failure	Replace CPU
F4/5	Internal clock battery	Heaters remain on, but fault condition persists	Battery-backed RAM battery dead	Replace CPU
F4/6	Analog-to-digital	Melter stops functioning	RTD analog-to-digital converter failed	Replace main board or CPU

*Continued...*

## Melter Faults *(contd)*

Table 6-1 Melter Faults *(contd)*

Display Code/Sub-code	Name	Affect on Melter	Cause	Corrective Action
F4/7	Analog-to-digital calibration	Melter stops functioning	Failed hose or gun  RTD analog-to-digital converter could not be calibrated (grounded RTD in system)	Replace hose or gun. Note: Set setpoint to zero to avoid F1 fault. Replace main board or ribbon cable, or CPU
F4/8	Main board feedback	Melter stops functioning	Communication failure between main board and CPU	Replace main board, ribbon cable, or CPU
F4/9	Expansion board feedback	Melter stops functioning	Communication failure between expansion board and main board	Check the ribbon cable connections between the expansion board and the main board.
F4/A	Thermostat	Melter stops functioning	Tank or manifold thermostat is open	Replace thermostat, J7 harness, or main board
F4/d	Communications with optional I/O card	Heaters remain on, but fault condition persists	Communication failure between CPU and the optional I/O card	Replace the I/O card or CPU
F4/E	Fieldbus communications failure	Alert output (if output option 6 is selected) Melter continues to operate normally.	Fieldbus card failure.	Replace the Fieldbus card

# Motor Control Faults

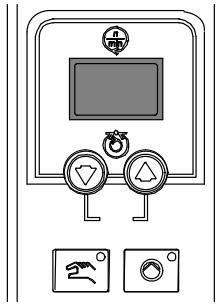

Pump speed display

Table 6-2 lists the motor control fault codes that may appear on the pump speed display(s).

Table 6-2 Motor Control Faults

Motor Control Fault	Possible Cause	Corrective Action
no EnA (motor control fault code shown on pump speed display)	<b>Master pump enable key</b> not turned on	Press the <b>Master pump enable key</b> until the LED is illuminated.
hOt (motor control fault code shown on pump speed display)	Motor thermostat open	Wait for the motor to cool, ensure that the pump speed setting is not too low, and then restart the pump. If the hOt code continues to appear, troubleshoot the problem that is causing the motor to overheat, such as binding or blockage in the pump, a locked pump rotor, etc.
Displayed rpms do not match motor speed	Pump speed display not calibrated	Calibrate the pump speed display. Refer to <i>Calibrating the Pump Speed Display</i> .
Motor control not operating as expected	Improper motor control parameter settings	Check motor control parameter settings. Refer to <i>Changing a Motor Control Parameter</i> in this section.

## Changing a Motor Control Parameter

The motor control parameters are factory set and do not need to be changed. Use this procedure only if a motor control parameter is inadvertently changed and needs to be changed back to the factory setting shown in Table 6-3. The motor control parameters are changed through the motor control panels located on the front of the melter.

### To change the a motor control parameter

1. Place the main power switch in the OFF position.
2. Place the control switch in the OFF position.

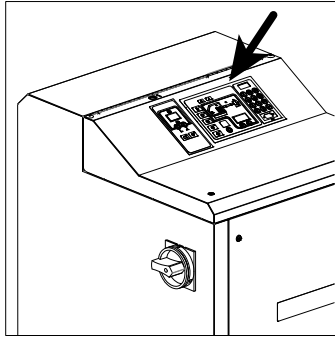

Control switch

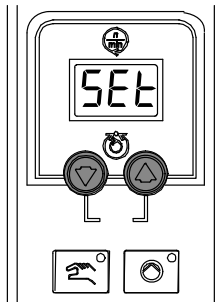

Pump speed arrow keys

3. Press and hold both **Pump speed arrow** keys and then switch the control switch back on. When the pump speed display indicates SEt, release the keys.
4. Use the **Pump speed arrow** keys to select a value for the parameter shown on the pump speed display. Refer to Table 6-3 for a parameter list.

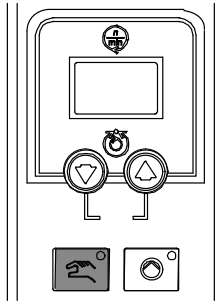

Pump mode key and LED

5. Press the **Pump mode** key to save the value and move to the next parameter.
6. Repeat steps 3-4 for each parameter you want to change.
7. To exit the setup mode, press the **Pump mode** key one additional time after the last parameter has been displayed.

Table 6-3 Motor Control Parameter Factory Settings

Parameter	Factory Setting	Description	Explanation
SEt	94	Maximum pump rpm	This parameter controls the increment of change in motor speed that occurs upon each press of a pump speed up or down arrow key when the melter is operating in the manual mode. To change the rpm in increments of 1, set this parameter to the maximum pump rpm.
Srt	0	Motor start mode	This parameter controls the method used to start the motor(s):  To start a motor by pressing the pump start/stop key on a motor control panel, enter 0. This setting is typically used if a melter has more than one motor.  If you want a motor to start when the pump enable signal is activated, enter 1. This setting is typically used if a melter has only one motor.
LoS	0	Minimum pump speed in gear-to-line mode	If the melter will be operated in the manual mode, enter 0.  If the melter will be operated in the gear-to-line mode, enter a minimum line speed. The motor speed will not fall below this value even if the signal drops to 0 V.

## Motor Drive Faults

The display on the motor drive located inside the electrical enclosure alerts the operator to abnormal motor drive/motor operation. Motor drive faults cause the pump to stop, refer to the motor drive *Error Messages* given later.

To clear a motor drive fault, correct the problem that caused the fault and then remove power from the motor drive by turning the heaters off and wait until the motor drive display is completely blank.



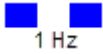







Figure 6-1 Motor drive power LED and display

1. Motor drive Ready (RDY) LED
2. Motor drive Error (ERR) LED



## LED Status Display

The motor drive has two LEDs, READY (RDY) and ERROR (ERR), see LED location on Figure 6-1. Refer to the following table to identify the motor drive state:

RDY (Blue)	ERR (Red)	Motor Drive State
–	–	No supply voltage
	–	STO active
		STO active, warning active
	–	Motor drive inhibited
		Motor drive inhibited, DC Voltage not On OR Reset
		Motor drive inhibited, Warning active
		Motor drive inhibited, Fault active
	–	Motor drive released, drive running OR Quick Stop
		Motor drive released, drive running, Warning active
		Motor drive released, Trouble reaction active

# Motor Drive Error History

## Error History

The motor driver keypad is not shipped with the melter, to view the error history you will need to order the keypad service kit (P/N 7411739) separately.

Any time the motor drive experiences an Error condition during operation it is captured in the motor drive non-volatile memory. For historical Error tracking purposes the Errors can be viewed in P155.00. This parameter contains the actual Error codes, the time (in running hours) that the Error occurred and the count of Errors (in case of multiple instances of the same Error condition). The Error History will retain the 32 most recent Errors.

The following figure explains each component in the Error History data:

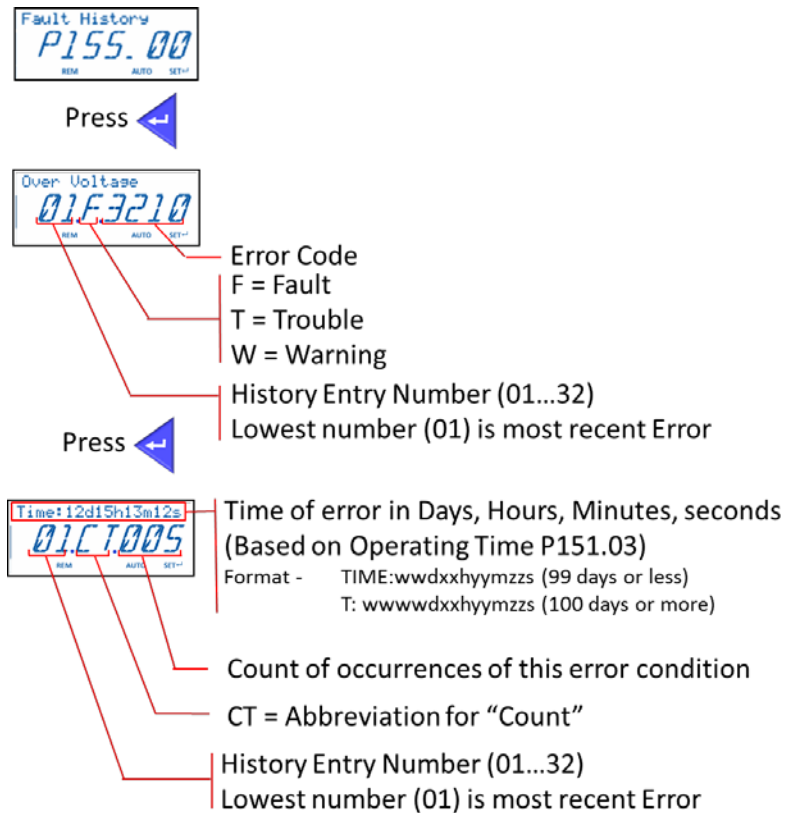





Figure 6-2 Explanation of the Error History data

**NOTES:**

Press  to toggle between two screens.

Press  and  to navigate from Error 01 to Error 32.

The following is an example of how to navigate Error History :

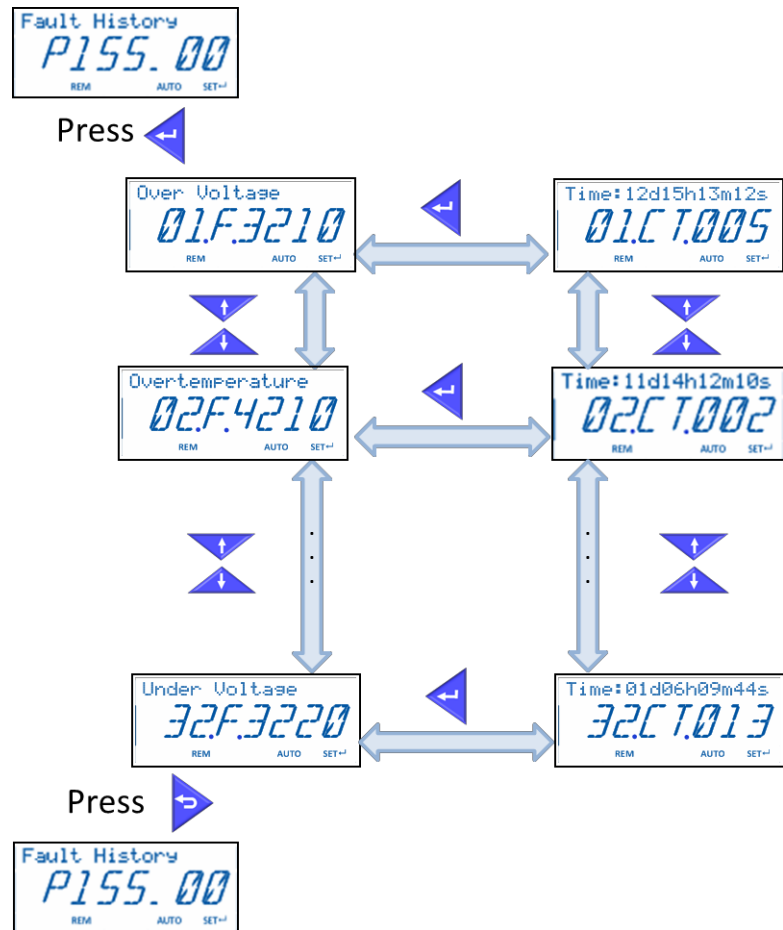

Figure 6-3 Navigating Error History

## Error Messages

Error Code (Hex)	Error Code (Dec)	Fault Type	Keypad	Description
0x2220	8736	Fault	OC power mod.	CiA: Continuous over current (device internal)
0x2230	8752	Fault	F.Ground short	CiA: Short circuit/earth leakage (device internal)
0x2250	8784	Fault	OC pm short	CiA: Short circuit (device internal)
0x2351	9041	Configurable	OL i2t motor	CiA: Load level fault (I2t, thermal state)
0x2382	9090	Configurable	F.ixt	Ixt fault
0x2383	9091	Warning	W.ixt	Ixt warning
0x3000	12288	Fault	F.Su02	Single phase fault
0x3210	12816	Fault	F.OU	DC link circuit over-voltage
0x3220	12832	Trouble	F.LU	DC link circuit under-voltage
0x4210	16912	Fault	F.OH1	Power module overtemperature fault
0x4211	16913	Warning	W.OH1	Power module overtemperature warning
0x4310	17168	Configurable	OT motor	Motor temperature has reached error level
0x4481	17537	Fault	sens. heatSink	Heat sink temperature sensor fault
0x5003	20483	Fault	F.ID1	Motor parameter identification fault
0x5112	20754	Warning	W.24V supply	24V supply level critical
0x5581	21889	Fault	Programming err	Power unit programming fault
0x5582	21890	Fault	EPM full	EPM full
0x5584	21892	Fault	Eeprom fault	On-board eeprom access failure
0x5585	21893	Fault	EPM store E	EPM data was not completely saved before power down
0x6104	24836	Warning	Watchdog reset	Watchdog time-out
0x610A	24842	Fault	F.dF12	Math error
0x6181	24961	Fault	OL 125us task	Calculation time overrun in 125us task
0x6182	24962	Fault	OL 250us task	Calculation time overrun in 250us task
0x6183	24963	Fault	OL 1ms task	Calculation time overrun in 1ms task
0x6184	24964	Fault	OL 8ms task	Calculation time overrun in 8ms task
0x6200	25088	Fault	User set fault 1	Digital connection list user fault 1
0x6201	25089	Fault	User set fault 2	Digital connection list user fault 2
0x6307	25351	Fault	F.AL	Assertion level fault
0x8100	33024	Configurable	CAN bus off	CAN bus off
0x8101	33025	Configurable	CAN bus warning	CAN warning
0x8109	33033	Configurable	Stack init error	Fieldbus communication stack initialization error

Continued...

Error Code (Hex)	Error Code (Dec)	Fault Type	Keypad	Description
0x8111	33041	Configurable	TO RxPDO1	CAN time-out Rx PDO 1
0x8112	33042	Configurable	TO RxPDO2	CAN time-out Rx PDO 2
0x8113	33043	Configurable	TO RxPDO3	CAN time-out Rx PDO 3
0x8131	33073	Configurable	CAN hbeat C1	CAN heartbeat time-out consumer 1
0x8132	33074	Configurable	CAN hbeat C2	CAN heartbeat time-out consumer 2
0x8133	33075	Configurable	CAN hbeat C3	CAN heartbeat time-out consumer 3
0x8134	33076	Configurable	CAN hbeat C4	CAN heartbeat time-out consumer 4
0x8141	33089	Configurable	WD exprd	Fieldbus watchdog expired
0x8142	33090	Configurable	Cycl data left	Fieldbus disruption of cyclic data exchange
0x8143	33091	Configurable	Inval cycl data	Fieldbus invalid cyclic process data
0x8190	33168	Configurable	TO Modbus	Modbus network time-out
0x8191	33169	Warning	Modbus EC	Modbus wrong request from master
0x8192	33170	Fault	FLBS new module	Fieldbus new module detected fault
0x8193	33171	Fault	FLBS cfg error	Fieldbus module configuration mismatch fault
0x8286	33414	Configurable	F.PDO mapping	Fieldbus PDO mapping error
0xFF06	65286	Configurable	OS motor	Motor over speed
0xFF09	65289	Configurable	F.VolPhases	Motor phase failure
0xFF0A	65290	Configurable	F.VolPhaseU	Motor phase failure phase U
0xFF0B	65291	Configurable	F.VolPhaseV	Motor phase failure phase V
0xFF0C	65292	Configurable	F.VolPhaseW	Motor phase failure phase W
0xFF0D	65293	Configurable	OC motor	Motor over current
0xFF10	65296	Configurable	F.AIn01	Analog input 1 fault
0xFF13	65299	Configurable	F.AIn02	Analog input 2 fault
0xFF15	65301	Warning	W.UV dc link	DC link circuit under-voltage warning
0xFF16	65302	Warning	F.AOut01	Analog output 1 fault
0xFF18	65304	Warning	W.OV dc link	DC link circuit over-voltage warning
0xFF19	65305	Warning	F.AOut02	Analog output 2 fault
0xFF40	65344	No response	TMO no reaction	Test monitor generated no reaction
0xFF41	65345	Warning	TMO warning	Test monitor generated warning
0xFF42	65346	Trouble	TMO trouble	Test monitor generated trouble
0xFF43	65347	Fault	TMO fault	Test monitor generated fault
0xFF44	65348	Fault	TMO fault delay	Test monitor generated fault with fault reset delayed
0xFF45	65349	Fault	TMO fault block	Test monitor generated fault with fault reset blocked
0xFF48	65352	Fault	Safety fault	Safety supervision fault
0xFF49	65353	Fault	EPM invalid data	EPM contains invalid user data
0xFF50	65360	Fault	EPM not present	EPM not present

*Continued...*

**Error Messages** (contd)







Error Code (Hex)	Error Code (Dec)	Fault Type	Keypad	Description
0xFF51	65361	Fault	id tag error PU	Load error of the id tag calibration data power unit
0xFF52	65362	Fault	id tag error CU	Load error of the id tag calibration data control unit
0xFF53	65363	Fault	Improper connect	Connection list wrong connected
0xFF54	65364	Configurable	F.fdb open circ	Feedback system open circuit
0xFF56	65366	Warning	OL modbus tx	Modbus transmit message ring buffer error
0xFF57	65367	Configurable	OL diag. rx	Diagnosis receive message ring buffer error
0xFF58	65368	Configurable	OL diag. tx	Diagnosis transmit message ring buffer error
0xFF59	65369	Fault	EPM access fault	EPM access failure
0xFF60	65376	Warning	F.fan heatsink	Heat sink fan fault
0xFF61	65377	Warning	F.fan internal	Internal fan fault
0xFF62	65378	Warning	Reverse protect	Reverse direction protection warning
0xFF63	65379	Fault	F. pole ident	Pole position identification fault
0xFF64	65380	Trouble	Sync error CU PU	Power stage communication is out of synchronization
0xFF65	65381	Fault	PSCOM mismatch	Power stage communication protocol version mismatch
0xFF66	65382	Trouble	Rx error CU	Power stage communication receive error on control unit
0xFF67	65383	Fault	rx error PU	Power stage communication receive error
0xFF68	65384	Fault	PSCOM SDO abort	Power stage communication SDO abort
0xFF69	65385	Fault	F.PU generic	Power unit generic fault
0xFF70	65392	Fault	F.PU uC supply	Power unit uC supply voltage drop down
0xFF71	65393	Configurable	W.OC12	Brake resistor overload warning
0xFF72	65394	Configurable	F.OC12	Brake resistor overload fault
0xFF73	65395	Fault	Auto run inhibit	Automatic start inhibited
0xFF74	65396	Warning	TO.OBEE	OBEE job timer overrun
0xFF75	65397	Warning	TO.EEPROM.EPM	EPM job timer overrun
0xFF76	65398	Warning	I2C conn lost	I2C connection lost
0xFF77	65399	Warning	I2C bus error	I2C bus error
0xFF80	65408	Fault	Trouble overflow	Maximal allowed troubles exceeded
0xFF81	65409	Warning	W. powUp voltage	DC link voltage to low for power up
0xFF82	65410	Warning	EPM is blank	Installed EPM is blank
0xFF83	65411	Fault	Keypad removed	Keypad removed fault
0xFF84	65412	Fault	AC user fault	AC control user fault
0xFF85	65413	Fault	Netwrk user flt1	Network user fault 1
0xFF86	65414	Fault	Netwrk user flt2	Network user fault 2
0xFF87	65415	Fault	NetWordIN1 Setup	NetworkIN1 duplicate bit connection fault

# Changing a Motor Drive Parameter

## Keypad



The motor drive parameters are pre-set at the factory. You need the motor drive keypad with display to view and change the motor drive parameters. Install the keypad on the front of the motor drive.

An explanation of the keypad button functions is given in the following table.

Keypad	Buttons	Description
		<ul style="list-style-type: none"> <li>• Menu navigation</li> <li>• Adjust parameter values</li> </ul>
		<ul style="list-style-type: none"> <li>• Enter (sub-) menu/parameter</li> <li>• Confirm parameter</li> </ul>
		Exit (sub-) menu/parameter
		Stop motor drive
		Release motor drive

## Display

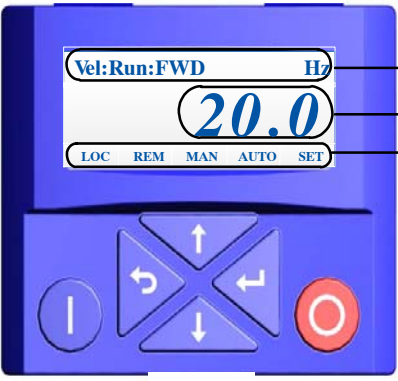
An explanation of the display parameters is given in the following table.

Display	Item	Description
	1	Status and unit
	2	Speed, Parameter value, and Fault code
	3	<ul style="list-style-type: none"> <li>• LOC – Local start button on keypad is active (stop button is always active)</li> </ul>
		<ul style="list-style-type: none"> <li>• REM – Local start button is inactive (start is initiated remotely)</li> </ul>
		<ul style="list-style-type: none"> <li>• MAN – Up/Down arrows are active and control speed</li> <li>• AUTO – Up/Down arrows are inactive (speed control is external)</li> <li>• SET  – The blinking indicates that a setting or value has changed and needs to be entered. Once the settings are saved, the icon is steady</li> </ul>

## Display *(contd)*

Every parameter has a hexadecimal address. Parameters which are visible on the keypad also have a display code. In the *Easy Starter Display Code* and hexadecimal address are visible. Every parameter can have sub-parameters.

Example	Display code	Address
V/f base frequency	P302.02	0x2B01:002
Start control	P200.00	0x2824:000

The parameters are organized into groups 0 through 7:

Group	Name	Group	Name
0	Favorites menu	4	Function and I/O menu
1	Diagnostics	5	Network setup menu
2	Basic setup	6	Process control menu
3	Motor setup	7	Auxiliary function menu



The favorites menu contains links to the most commonly used parameters for initial commissioning and monitoring of the motor drive for general applications.



## Favorites Group Navigation

Screen Type	Display Parameters	Keypad Button Selection
Operating Screen		Press
Groups Screen		Press
Parameter Screen		Press ten (10) times
Parameter Screen		Press
Setting Screen		Press until 87.0 is displayed
Setting Screen		Press
Parameter Screen		 <b>NOTE:</b> Use the Up and Down buttons to navigate to other parameters in Group 0. In this example, the BACK button is used to return to Group list.
Groups Screen		 <b>NOTE:</b> Use the Up and Down buttons to navigate to other groups. In this example, the BACK button is used to return to the Operating Screen.

*Continued...*

## Favorites Group Navigation *(contd)*

Screen Type	Display Parameters	Keypad Button Selection
Operating Screen		We are at the Operating Screen.



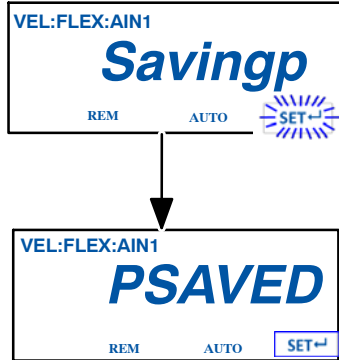





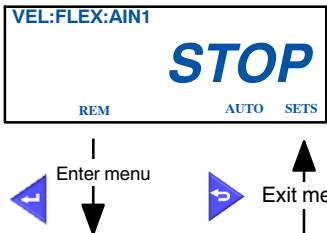
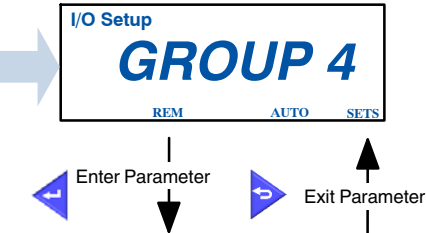

## Saving the Settings

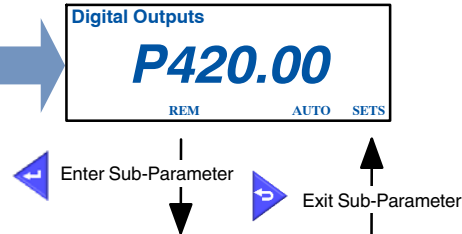

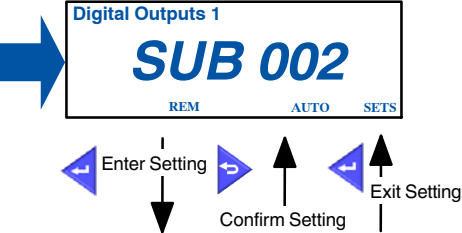
After the adjustments are complete, press  for three (3) seconds to save all the settings to memory.

The **SET**  icon blinks when the settings are not saved. Once the settings are saved, the icon is steady.

## Navigation Group 1-7

Screen Type	Display Parameters	Keypad Button Selection
Operating Screen		
Groups Screen		Press  or  to select Group.
Parameter Screen		Press  or  to select Parameter.
Sub-Parameter Screen	<p><b>NOTE:</b> If Sub-Parameter screen is not available, the Direct Setting Screen will display.</p> 	Press  or  to select Sub-Parameter.
Setting Screen		Press  or  to change parameter value.

## Saving the Settings

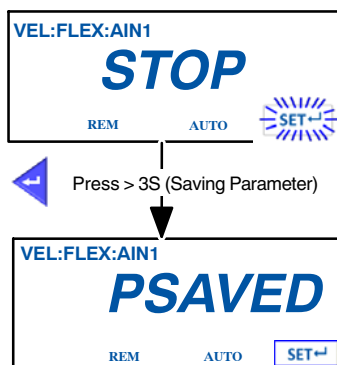

After all the adjustments are complete, press  for three (3) seconds to save all the settings to memory.

The **SET** icon blinks when the settings are not saved. Once the settings are saved, the icon is steady.

## Motor Drive Parameter Factory Settings

Code	Pr.	Description	Setting
GROUP2	P211:00	Max Frequency	102Hz
GROUP3	P303:01	Base Voltage	230V
GROUP3	P303:02	Base Frequency	102Hz
GROUP3	P315:01	Slip Compensation	5%
GROUP3	P320:04	Motor Speed	1350
GROUP3	P320:05	Motor Frequency	102
GROUP3	P320:06	Motor Power	0.25
GROUP3	P320:07	Motor Voltage	230
GROUP3	P320:08	Motor cos PHi	0.6
GROUP4	P430:03	Frequency at max signal	102Hz

## Calibrating the Pump Speed Display

The melter is shipped with the pump speed display calibrated to show the pump rpm. If recalibration becomes necessary, follow this procedure.

1. Ensure that the motor is running at 50 percent speed or higher.
2. Press and hold both **Pump speed arrow** keys.
3. When the pump speed display indicates CAL, release the keys.
4. Enter the actual pump rpm.

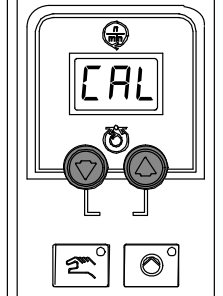

Pump speed arrow keys

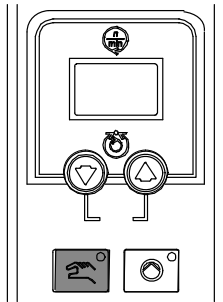

Pump mode key and LED

5. Press the **Pump mode** key.

## Troubleshooting Tables

### Melter Not Functioning

Possible Cause	Possible Fault / Troubleshooting	Corrective Action
1. No line voltage	—	Connect line voltage
2. Main power switch not switched on	—	Place main power switch in ON position
3. Main power switch defective	—	Replace main power switch
4. Main circuit breaker activated	—	Switch on main circuit breaker
5. Main circuit breaker activated again	Check for short circuit in melter or accessories	—
6. 24 VDC power supply defective	—	Replace
7. Frequent melter shutdown	Electromagnetic compatibility disruptions	Add mains filter

### One Channel (Heating Zone) Does Not Heat

Possible Cause	Possible Fault / Troubleshooting	Corrective Action
1. Channel is disabled / switched off	—	Enable / switch on

### Control Panel Does Not Function

Problem	Possible Cause	Corrective Action
1. Display is blank	SPS broad-band cable not connected	Connect

## No Material (Motor Does not Rotate)

Possible Cause	Possible Fault / Troubleshooting	Corrective Action
<b>1. Melter not yet ready for operation (heatup phase)</b>	—	Wait until the melter has heated up and the green indication lamp is lit
<b>2. Melter at present not ready for operation (undertemperature during operation)</b>	Material was refilled	Wait until the melter has heated up and the green indication lamp is lit
<b>3. Motor not enabled</b>	—	Enable motor
<b>4. Speed (rpm) not set</b>	—	Set speed (rpm)
<b>5. Standby entered</b>	—	Exit or wait until standby period has expired
<b>6. Motor overheated</b>	Ambient temperature too high  Fan cap dirty Pump blocked by foreign matter Pump operates too sluggish Material too cold	Decrease ambient temperature by cooling or airing out  Clean Replace pump Replace pump Set temperature accordingly
<b>7. Motor defective</b>	—	Replace
<b>8. Motor not supplied with voltage</b>	—	Technical inspection
<b>9. Motor drive fault</b>	—  Motor overheated Motor controller overheated  Short circuit Overload (pump blocked by foreign matter, pump too sluggish, material too cold)	Switch melter off and on again with main power switch  See above Decrease ambient temperature by cooling or airing out Clean cooling section of motor controller Check motor cable Refer to 6.
<b>10. Motor drive defective</b>	—	Replace

## No Material (Motor Rotating)

Possible Cause	Possible Fault / Troubleshooting	Corrective Action
1. Tank empty	—	Fill tank
2. Filter cartridge clogged	—	Clean or replace filter screen
3. Material supply hole to pump or pump suction hole clogged	—	Detach pump and clean supply hole or suction hole
4. Pressure control valve defective	—	Replace pressure control valve
5. Safety valve defective	—	Replace safety valve
6. Pump defective	—	Replace pump
7. Pressure control valve setting too low	—	Adjust pressure control valve

## Too Little Material

Possible Cause	Possible Fault / Troubleshooting	Corrective Action
1. Material supply hole to pump or pump suction hole partially clogged	—	Detach pump and clean supply hole or suction hole
2. Filter cartridge partly clogged	—	Clean or replace filter screen
3. Pressure control valve defective	—	Clean or replace
4. Processing temperature set too low	—	Correct temperature setting
5. Pump block is worn	—	Replace pump
6. Safety valve defective	—	Replace safety valve
7. Pump defective	—	Replace pump
8. Pressure control valve setting too low	—	Adjust pressure control valve



## Material Pressure Too High

Possible Cause	Possible Fault / Troubleshooting	Corrective Action
1. Pressure control valve dirty and thus blocked	—	Disassemble and clean or replace
2. Pressure control valve defective	—	Replace
3. Pressure control valve set incorrectly	—	Set to default

## Material Pressure Too Low

Possible Cause	Possible Fault / Troubleshooting	Corrective Action
1. Pump is worn	—	Replace pump
2. Pressure control valve does not close any more	—	Replace
3. Pressure control valve dirty and thus clogged	—	Disassemble and clean or replace
4. Pressure control valve defective	—	Replace
5. Pressure control valve set incorrectly	—	Set to default

## Material Residue in Tank

Possible Cause	Possible Fault / Troubleshooting	Corrective Action
1. Tank setpoint temperature set too high	—	Correct temperature setting
	Material of low quality or not appropriate for application (temperature resistance poor)	Consult material supplier

## Material Hardens in Tank

Possible Cause	Possible Fault / Troubleshooting	Corrective Action
1. Tank setpoint temperature set too high/too low	—	Correct temperature setting

## Others

Problem	Possible Cause	Corrective Action
1. Leakage at pump shaft seal	Pump shaft seal is worn	Tighten the gland bolt
	—	Replace pump
2. Material pressure too low, output quantity too low	Pump is worn	Replace pump
3. Pump blocked	Processed material too cold	Correct temperature setting (observe data sheet of material manufacturer)
	Foreign material in pump	Replace pump
4. Leakage at gun during heat-up phase	Safety valve does not open (expansion pressure)	Replace safety valve

## Section 7

# Parts

### *Using the Illustrated Parts List*

The parts lists provided in this section are organized into the following columns:

**Item**—Identifies illustrated parts that are available from Nordson Corporation.

**Part**—Provides the Nordson Corporation part number for each saleable part shown in the illustration. A series of dashes in the parts column (- - - - -) means the part cannot be ordered separately.

**Description**—Provides the part name, as well as its dimensions and other characteristics when appropriate. Bullets in the description, indicate the relationships between assemblies, subassemblies, and parts.

**Quantity**—The quantity required per unit, assembly, or subassembly. The code AR (As Required) is used if the part number is a bulk item ordered in quantities or if the quantity per assembly depends on the product version or model.

## ***Melter Part Numbers***

<b>Part</b>	<b>Description</b>
7401355	DuraBlue II,20L,SN0773,6HG,NI,400V WYE
7401356	DuraBlue II,45L,SN0773,6HG,NI,400V WYE

# Frame Assembly

## Melter Frame Parts

See Figure 7-1.

Item	Part	Description	Quantity	Note
	-----	MODULE,ENCL,1 MOTOR,DURABLU E II		
1	-----	CTL BOX,1 M,WITH FRONT PANEL, DURABLU E II	1	
2	-----	PANEL,MOTORS CHAMBER,LEFT,EZ	1	
3	-----	PANEL,ELEC CABINET,DURABLU E II	1	
4	-----	PANEL,MOTORS CHAMBER,FRONT, EZ	2	
5	-----	PANEL,HYDRAULIC,FRONT,EZ	2	
6	-----	FRAME,HYDRAULIC,FRONT,EZ	1	
7	-----	FRAME,HYDRAULIC,BACK,EZ	1	
8	-----	PANEL ASSY,HYDRAULIC,RIGHT,EZ	1	
9	-----	PANEL,COVER,MANIFOLD,EZ	2	
10	-----	HOOP,GUARD,HOSE CONNECTOR, EZ	1	
11	7411745	LID ASSY,HOPPER,EZ	1	

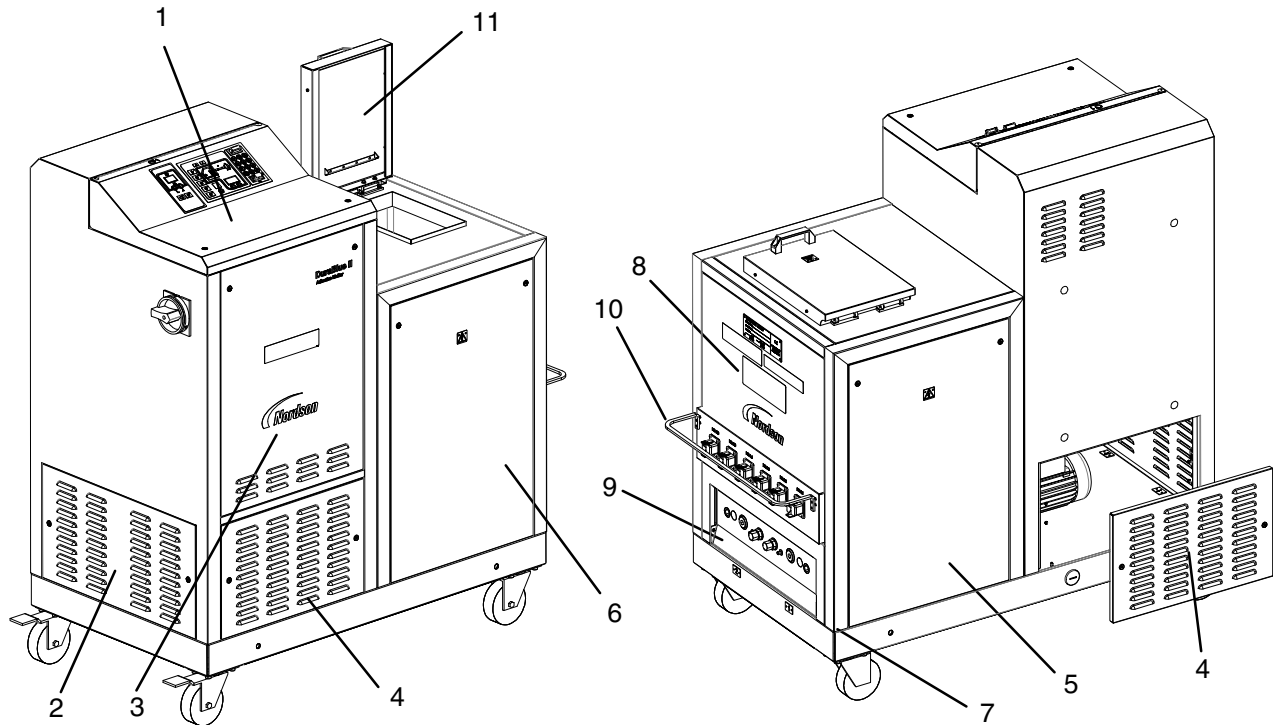

Figure 7-1 Sheet metal assembly parts

# Manifold Assembly

## 1-Single Stream Manifold Assembly

See Figure 7-2.

Item	Part	Description	Quantity	Note
—	-----	MODULE,MANIFOLD,1SS,20L,EZ	—	
101	7410539	• SUPPORT,HYDRAULIC,EZ	2	
102	7410538	• SUPPORT,MANIFOLD,SS,EZ	4	
103	-----	• MANIFOLD ASSY,EZ,2SS,20L	1	
104	7410544	• PLATE,INSULATOR,MANIFOLD, EZ	1	
105	-----	• SCR,HEX,CAP,M8X70,ZN	4	
106	-----	• SCR,SKT,M8X1.25X25,BL	4	
107	-----	• SCR,PAN,REC,M5X12,BL	8	
108	-----	• SCR,SKT,M5X10,BL	6	
109	-----	• WASHER,LK,M,SPT,M8,STL,ZN	8	
110	-----	• WASHER,FLT,M,REG,M8,STL,ZN	4	
111	-----	• WASHER,FLT,M,REG,M5,STL,ZN	8	
112	-----	• WASHER,LK,M,SPT,M5,STL,ZN	8	
113	-----	• SCR,SHCS,M4X6,BL	2	
114	1028305	• UNIT,FILTER,ASSEMBLY,100 MESH	1	
115	-----	• PLUG ASSY,FILETER,EZ	1	
116	1021270	• PLATE,FILTER,ANTI ROTATE	2	
117	-----	• SCR,PAN,REC,M4X8M,ZN	2	
118	-----	• WASHER,LK,M,EXT,M4,STL,ZN	2	
119	-----	• BALL, 8 MM	2	
120	-----	• SCREW, DRAIN VALVE	2	
121	-----	• RETAINING RING,INT,51,BASIC	2	
122	7410566	• VALVE,SHUT OFF,20L,EZ,SS	2	
123	7410541	• O-RING 24x2 VITON	2	
124	7410534	• PLATE,STOP,SHUT OFF VALVE, EZ	2	
125	985127	• PIN,DOWEL,M3X12,H&G	2	
127	900344	• LUBRICANT, NEVER SEEZ, 8 OZ CAN	1	
128	900223	• LUBRICANT, O-RING, PARKER, 4 OZ, 30122-5	1	
129	7410580	• SERVICE KIT,HEATER, 240V,800W, 1/2 X 16L	3	
130	-----	• WASHER,FLT,M,OVERSIZED,6,STL,Z	3	
131	207932	• SAFETY VALVE 85 BAR VB/DB FIX	2	
132	1058990	• KIT,CORDSTOCK,3MM OD,VITON,75D	1	
133	1024618	• THERMOSTAT,OOR,500DEG F,PUSH-ON TERM	1	
134	1030564	• PLATE, CAPTURE, RTD	1	
136	7411485	• COVER,BOTTOM,MANIFOLD,EZ	1	

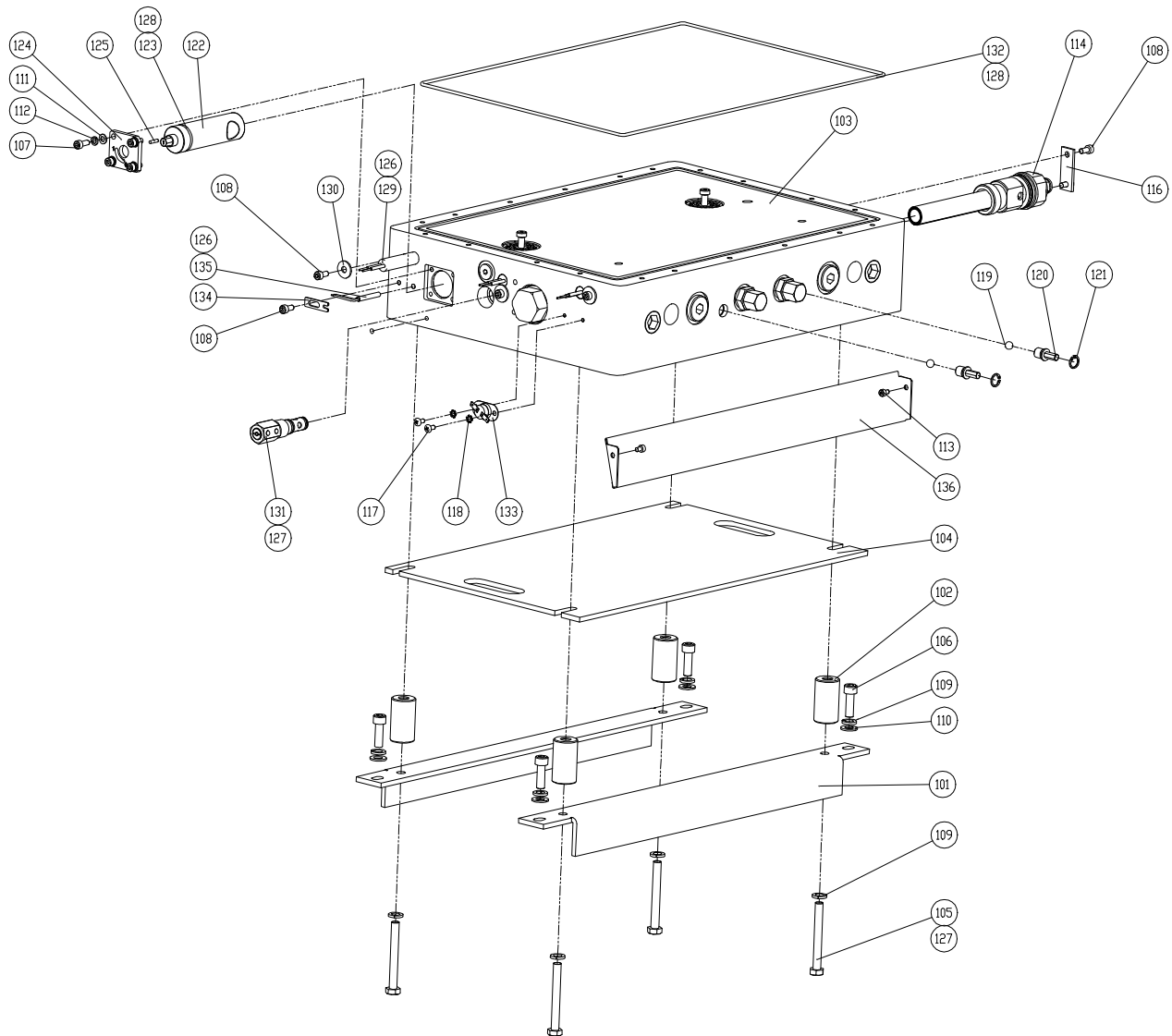

Figure 7-2 Manifold assembly parts

## Hopper Assembly

The hopper assembly parts vary depending on the size of the melter: one/two-pump, three/four-pump, or 100L. Refer to the correct parts list for your melter.

### Melter Hopper Parts

See Figure 7-3.

Item	Part	Description	Quantity	Note
—	-----	MODULE, HOPPER	—	
201	-----	• HOPPER, EZ, 20L	1	
	-----	• HOPPER, EZ, 45L	1	
202	7410545	• GASKET, HOPPER, EZ, 20L	1	
203	-----	• SCR, SKT, M6 X 20, BL	12	
204	-----	• WASHER, LK, M, SPT, M6,STL,EZ	12	
205	-----	• WASHER, FLT, M, SPT, M6,STL, EZ	12	
206	7410581	• SERVICE KIT, HEATER, 240V, 800W, 1/2 X 9.0 L	3	
207	-----	• SCR, SKT, M5 X 10, BL	5	
209	-----	• WASHER, M6, FLT, SPECIAL BIG, STL, ZP, GB96	3	
210	1024618	• THERMOSTAT, OOR, 500DEG F, PUSH-ON TERM	1	
211	-----	• WASHER, LK, M, EXT, M4, STL, EZ	2	
212	-----	• SCR, SHCS, M4 X 6, BL	2	
214	1030564	• PLATE, CAPTURE, RTD	1	
215	900298	• COMPOUND, HEAT SINK, 5 OZ TUBE	1	
216	7410542	• INSULATION, HOPPER, EZ, 20L	1	



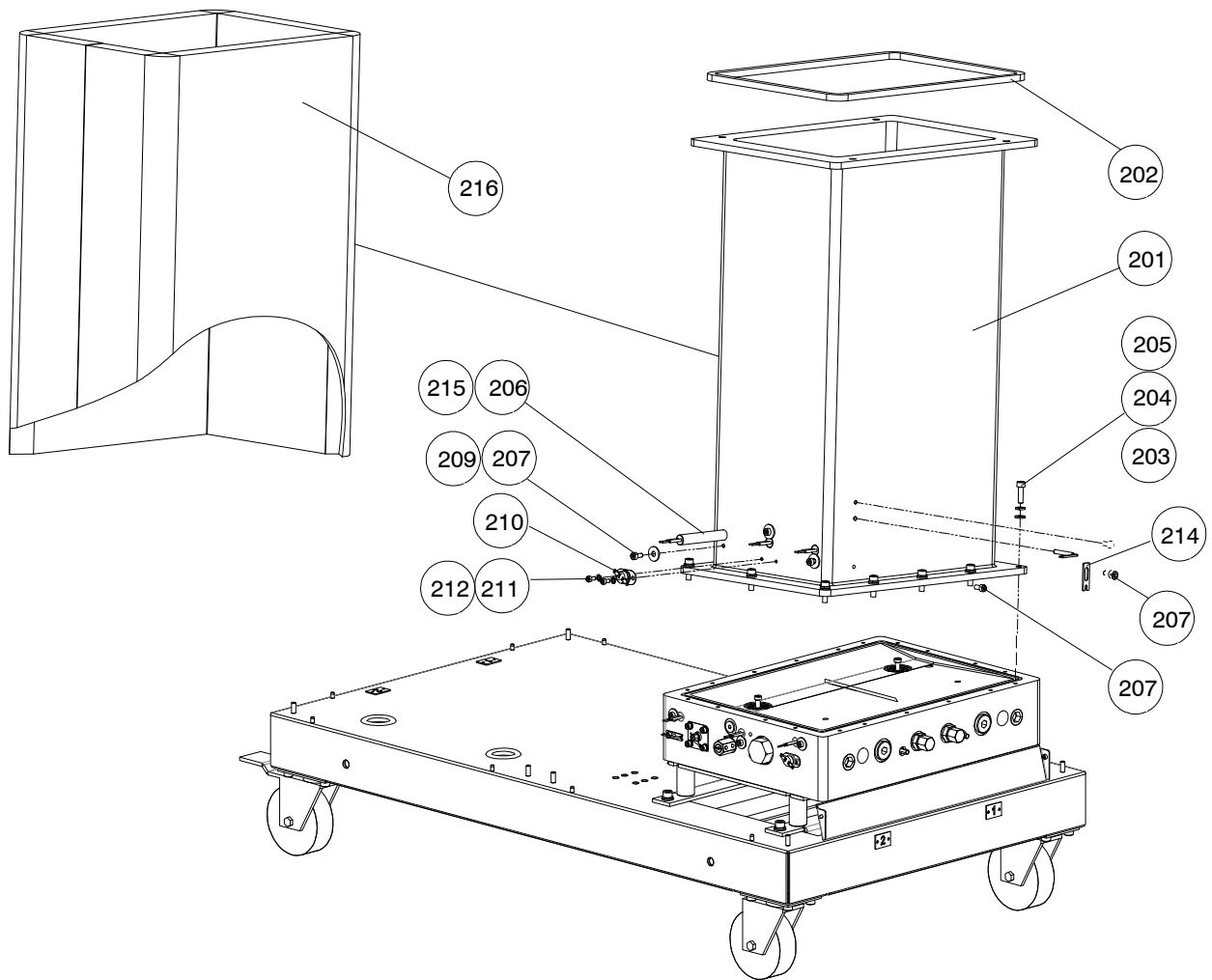

Figure 7-3 Melter hopper assembly parts (20L hopper shown)

# Pump Assemblies

## Drive Module Parts

See Figure 7-4.

Item	Part	Description	Quantity	Note
—	-----	EZ,MOTOR DRIVE,45L&20L, 1DS,EZ	—	
301	-----	• MOTOR UNIT,W/BACKET,EZ,R	1	A
302	-----	• BLANK ASSY,PUMP,DS,EZ	1	A
303	7402299	• COUPLING,M24,DAN/NORMAL	1	
304	-----	• SCR,SKT,M8X30,BL	4	
305	-----	• WASHER,FLT,M,REG,M8,STL,EZ	4	
306	-----	• WASHER,LK,M,SPT,M8,STL,EZ	4	
307	900344	• LUBRICANT, NEVER SEEZ, 8 OZ CAN	1	
390	-----	• DUAL - STREAM GEAR PUMPS	1	B

NOTE A: Refer to *Motor Assembly Parts*.  
 B: Refer to *Gear Pumps Parts*.

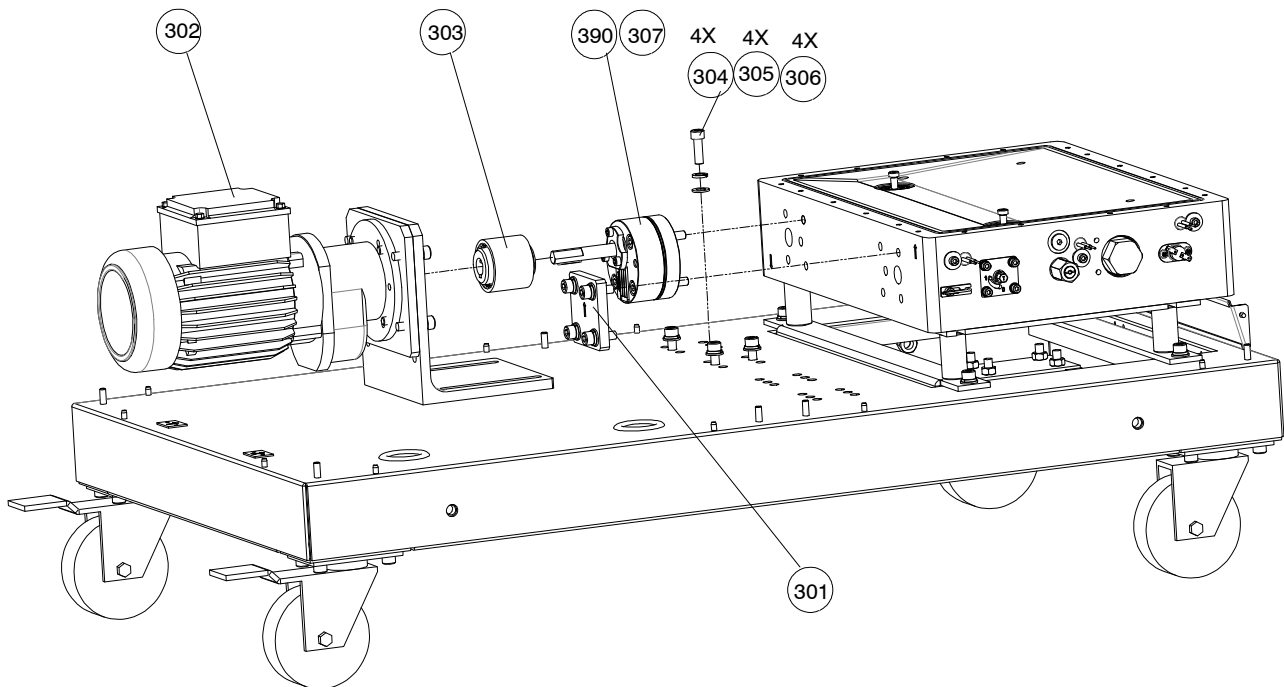

Figure 7-4 Pump module parts

## Single-Stream Gear Pumps

See Figure 7-5.

Item	Part	Description	Quantity	Note
—	729107	GEAR PUMP SN0773	1	

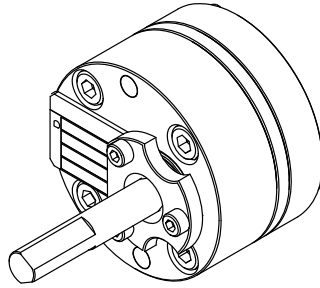

Figure 7-5 Single-stream gear pumps

## Safety Valve Parts

See Figure 7-6.

Item	Part	Description	Quantity	Note
—	207932	VALVE, SAFETY, 85 BAR	1	
—	394592	SERVICE KIT	1	
1	-----	• O-RING 11 X 2	1	
2	-----	• O-RING 9 X 2	1	
—	-----	• HIGH-TEMP. GREASE, GLS 595/N2, 10G	1	

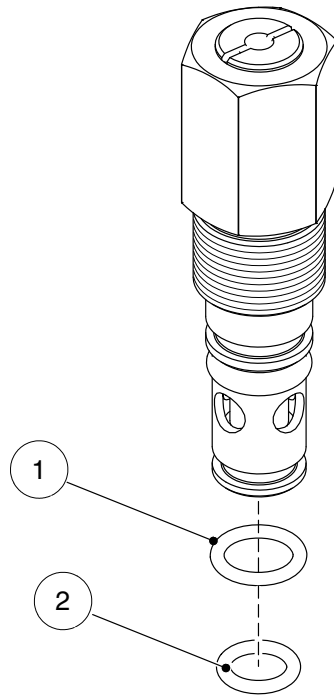

Figure 7-6 Safety valve parts

# Control Valve Assemblies

The control valve assemblies vary depending on the type of pressure control valve: pressure control valve, pneumatic pressure control valve, circulation control valve, or blank. Refer to the correct parts lists for your melter.

## Control Valve Module Parts

See Figure 7-7.

Item	Part	Description	Quantity	Note
—	-----	MODULE,PRESSURE CONTROL	—	
401	203059	PRESSURE CTRL VALVE 590 BAR VB/DB	2	
—	1070961	VALVE, CIRCULATION CONTROL, ALTABLUE	2	
—	-----	PLUG, PRESSURE REGULATOR VALVE VB/DB	2	
NOTE A: Refer to <i>Pressure Control Valve Parts</i> .				
NOTE B: Refer to <i>Circulation Control Valve Parts</i> .				

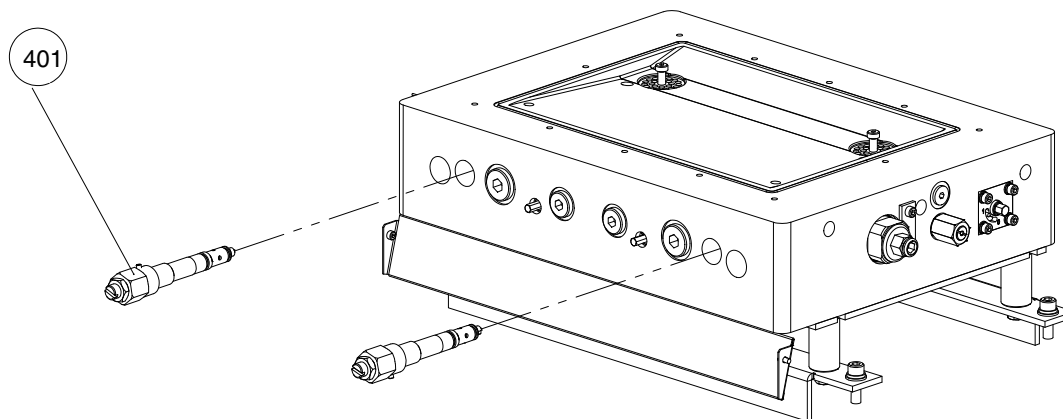

Figure 7-7 Pressure control module parts

## Filter Cartridge Parts

See Figure 7-8.

Item	Part	Description	Quantity	Note
01	1031235	FILTER, WITH O-RING, 50-MESH	1	
—	1028305	FILTER, WITH O-RING, 100-MESH	1	
—	1031236	FILTER, WITH O-RING, 200-MESH	1	

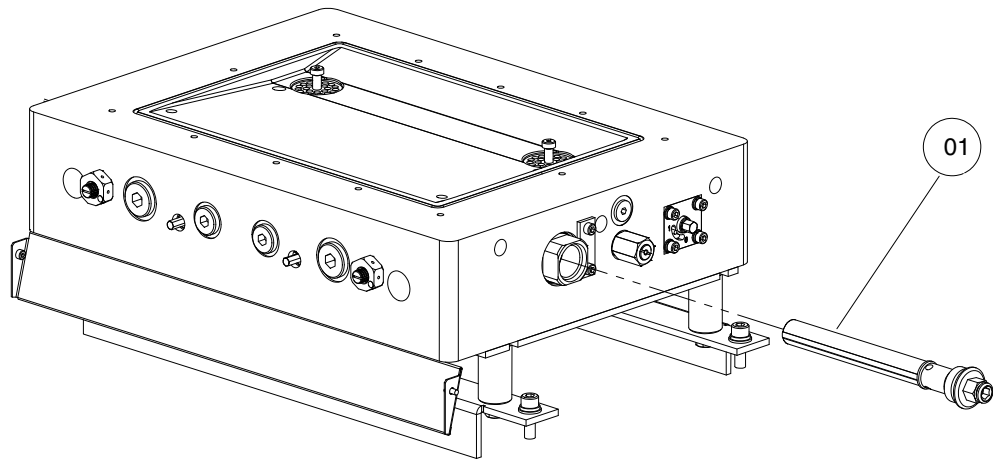

Figure 7-8 Filter cartridge parts

## Pressure Control Valve Parts

See Figure 7-9.

Item	Part	Description	Quantity	Note
—	203059	Valve, pressure control, adjustable, 90 bar	1	
1	-----	Body, valve	1	
2	-----	Piston, valve, supporting ring	1	
3	-----	Set screw, black, 90 bar	1	
4	-----	Compression spring, 2.2 x 7.4 x 34.4	1	
5	-----	O-ring, 6 x 2	1	
6	-----	O-ring, 11 x 2	1	
7	-----	O-ring, 9 x 2	1	
8	-----	Supporting ring, Da10, Di6.7, spiral	1	
—	394600	SERVICE KIT Pressure control valve	1	
6	-----	• O-ring 11 x 2	1	
7	-----	• O-ring 9 x 2	1	
—	-----	• High-temp. grease, GLS 595/N2, 10 g	1	

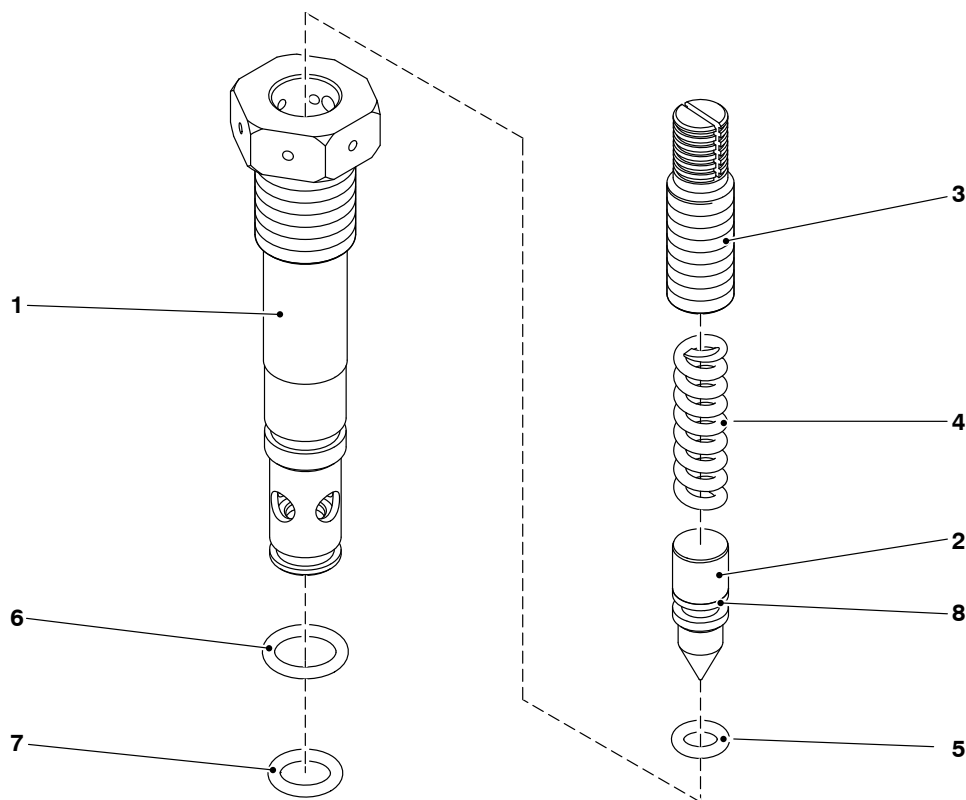

Figure 7-9 Pressure control valve parts

# Motor Assembly

See Figure 7-10.

Item	Part	Description	Quantity	Note
—	-----	MOTOR UNIT, W/BRACKET	—	
1	7410582	• SERVICE KIT,MOTOR,NDS-005 0.25KW	1	
2,3,4	7410583	• KIT,MOTOR BRACKET,ADJUST, EZ	1	
5	-----	• SCR, SKT, M8X30, BL	4	
6	-----	• WASHER, FLT, M, REG, M8, STL, ZN	4	
7	-----	• WASHER, LK, SPT, M8, STL, ZN	4	
8	7402299	• COUPLING, M24, DAN/NORMAL	1	

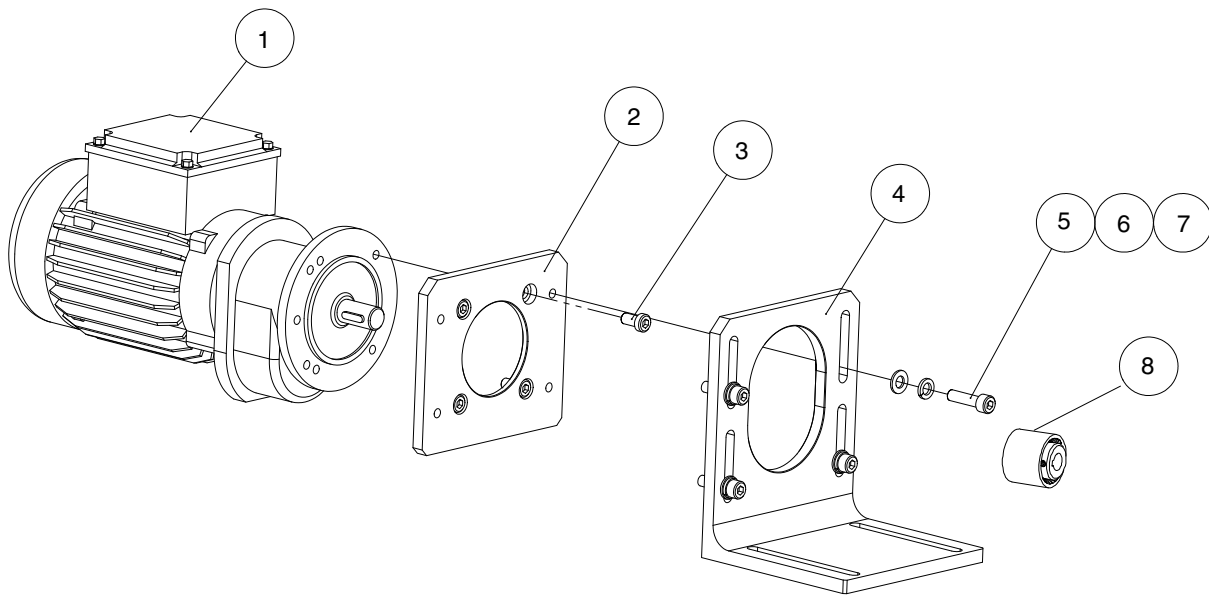

Figure 7-10 Motor assembly parts (four-pump melter shown)



This page intentionally left blank.

## Electrical Enclosure Panel Assemblies

The electrical enclosure panel assembly parts vary depending on the size of the melter: one/two-pump, three/four-pump, or 100L. Refer to the correct parts lists for your melter.

### Melter Left Panel Parts - 400V

See Figure 7-11.

Item	Part	Description	Quantity	Note
—	-----	400V ASSEMBLY, ELECTRICAL, PANEL, LEFT, ONE/TWO-PUMP	—	
1	-----	• PLATE ASSY,ELEC CABINET,LEFT,EZ	1	
2	7411712	• CIRCUIT BREAKER 32A 1-POLE	4	
3	7411708	• BOARD,BREAKOUT,RSMA-20D0CD,TB,20POS, EZ	1	
4	7411710	• CIRCUIT BREAKER 50A 3-POLES	1	
5	7411711	• CONTACTOR, 40A	1	
6	7410952	• RELAY, DC 24V	1	
7	777630	• BASE, RELAY (OMRON)	1	
8	-----	• CLIP,RELAY	2	
9	207396	• SOLID-STATE RELAY, G3PE 100-260V MAX. 15A	4	
10	7400070	• SOLID STATE RELAY,100-260VAC,35A,DC TRIG	2	
11	-----	• TERMINAL BLOCK POWER 400V WYE	1	
12	-----	• TERMINAL BLOCK, ZDU 16	4	
13	-----	• TERMINAL BLOCK, ZPE 16	1	
14	-----	• TERMINAL BLOCK, END PLATE, ZAP/TW, ZDU 16	1	
15	-----	• TERMINAL BLOCK, ZDU, 2.5	20	
16	-----	• EW35	12	
17	-----	• TERMINAL BLOCK, END PLATE ZAP/TW1	5	
18	-----	• TERMINAL CONNECTOR, ZQV2, 5/2	3	
19	-----	• HEXNUT, FLANGED, SERRATED, M5	2	

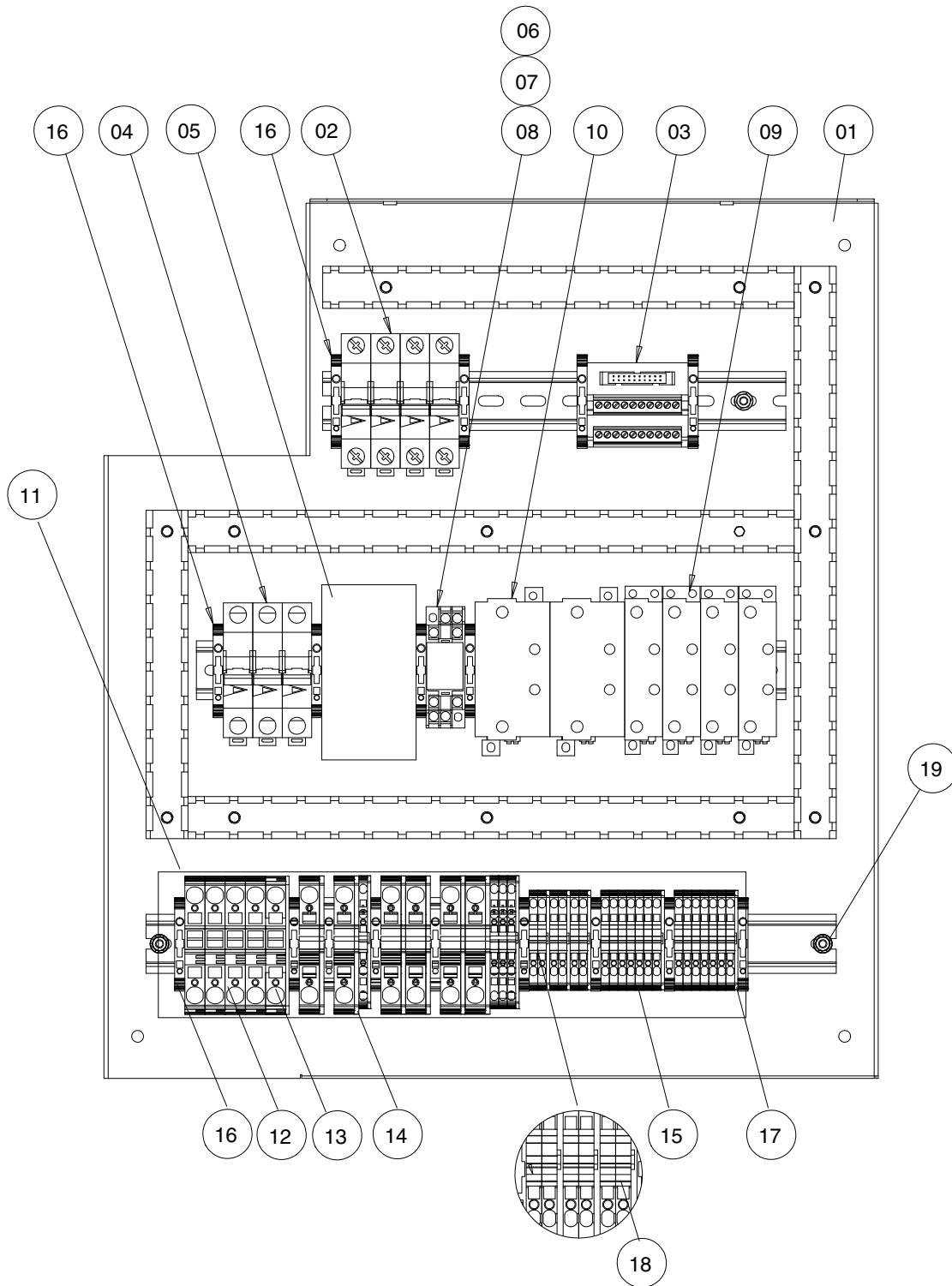

Figure 7-11 Left panel assembly parts (400V melter shown)

## Melter Back Panel Parts - 400V

See Figure 7-12.

Item	Part	Description	Quantity	Note
—	-----	400V ASSEMBLY, ELECTRICAL, PANEL, BACK, ONE/TWO-PUMP	—	
1	-----	• PLATE ASSY,ELEC CABINET,BACK, EZ	1	
2	7411713	• CIRCUIT BREAKER 16A 1-POLE	1	
3	7411735	• SERVICE KIT,MOTOR CONTROL,EZ	1 or 2	
4	-----	• TERMINAL BLOCK, ZDU, 2.5	8	
5	-----	• EW35	4	
6	-----	• TERMINAL BLOCK, END PLATE ZAP/TW1	1	
7	-----	• TERMINAL CONNECTOR, ZQV2, 5/2	2	
8	-----	• HEXNUT, FLANGED, SERRATED, M5	2	

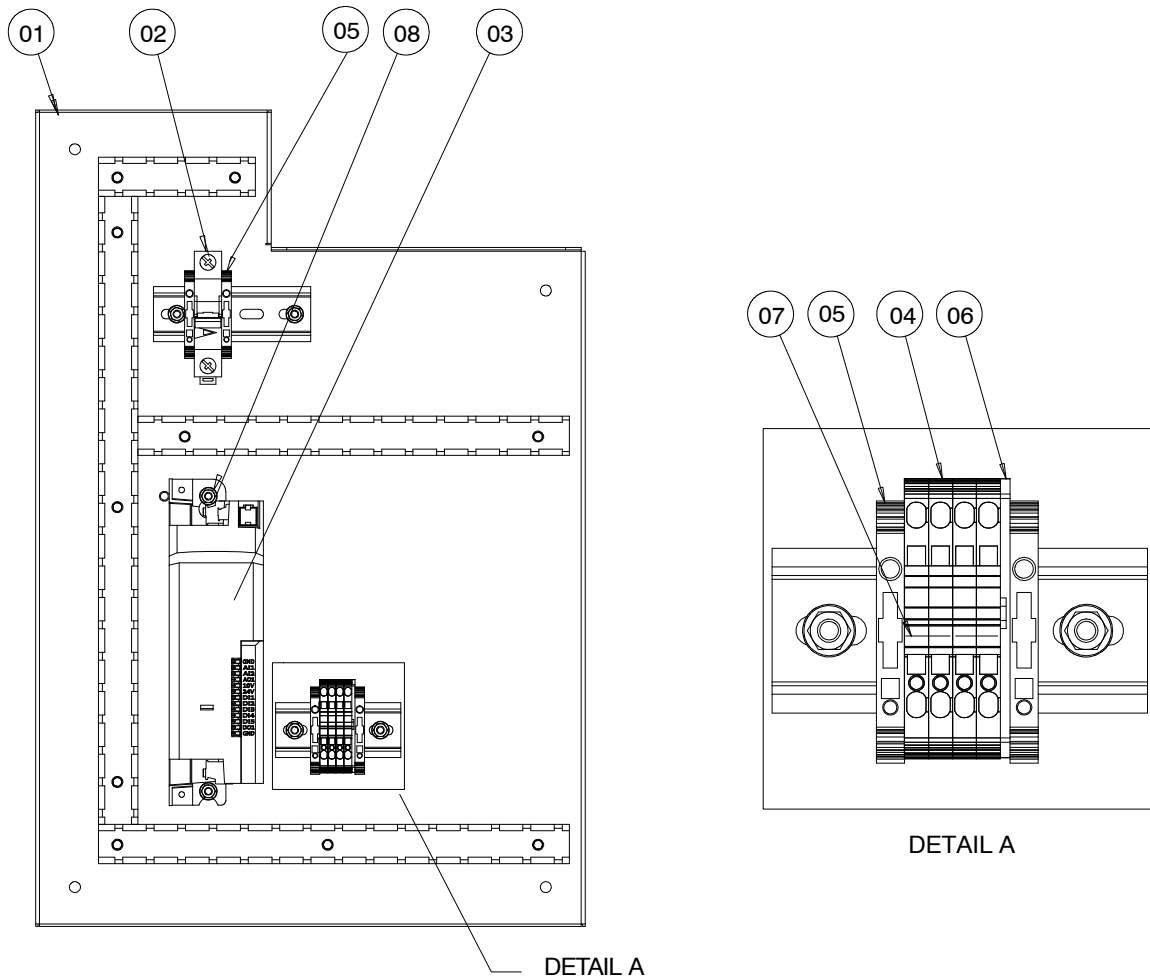

Figure 7-12 Melter back panel assembly parts (400V melter shown)

This page intentionally left blank.

## Melter Right Panel Parts - 400V

See Figure 7-12.

Item	Part	Description	Quantity	Note
—	-----	400V ASSEMBLY, ELECTRICAL, PANEL, BACK, ONE/TWO-PUMP	—	
1	-----	• PLATE ASSY,ELEC CABINET,BACK, EZ	1	
2	1122064	• SVCE KIT,MAIN,PCA	1	
3	1122974	• SVCE KIT, DURABLUE, EXPANSION PCA	1	
4	1031175	• SVCE KIT, DURABLUE, 2H TO 4H CONVERSION	1	
5	7410952	• RELAY,DC24V	1	
6	777630	• BASE, RELAY (OMRON)	1	
7	7400010	• CLIP,RELAY	2	
8	227569	• Jumper3/N/PE,AC 400-230V	1	
9	-----	• TERMINAL BLOCK,28POS,I/O	1	
10	-----	• terminal block ZDK 2,5/1,5 PE	1	
11	-----	• terminal-end-plate ZAP/TW ZDK2,5/1,5	1	
12	-----	• TERMINAL BLOCK,ZPE 4	1	
13	-----	• TERMINAL BLOCK,END PLATE,ZAP/TW 4 DB	1	
14	-----	• EW35	1	
15	-----	• HARNESS,1PH PWR,EXP-LE,ADVANTAGE	1	
16	-----	• HARNESS,RELAY PWR,EXP-LE,DURABLUE	1	
17	7400352	• RIBBON CABLE ASSY,20POS,2 HEATERS,400V	1	
18	-----	• HARNESS,ENABLE RELAY TO EXP J1,ALTABLUE	1	
19	-----	• HARNESS I/O,EZ	1	
20	-----	• HARNESS XT2 TO J4 J5,6HG,EZ	1	
21	-----	• EXPANSION BOARD XT5 WIRES ASSY. EZ	1	
22	-----	• FERRULE,WIRE,22AWG,INS,WHITE	18	
23	-----	• SCR,PAN,REC,W/WASHER,M4X10,ZN	4	
24	-----	• SCR,PAN,REC,M3X8,ZN	7	
25	-----	• LOCKWSHRM,EXT,M3,STL,ZN	7	
26	-----	• SCR,PAN,REC,M4X10,ZN	4	
27	-----	• WASHER,LK,M,EXT,M4,STL,ZN	4	
28	-----	• HEXNUT,FLANGED,SERRATED,M5	2	
29	-----	• SCR,PAN,SLT,M3X10,ZN	2	
30	-----	• WASHER,FLT,M,REG,M3,ZINC PLATE	2	

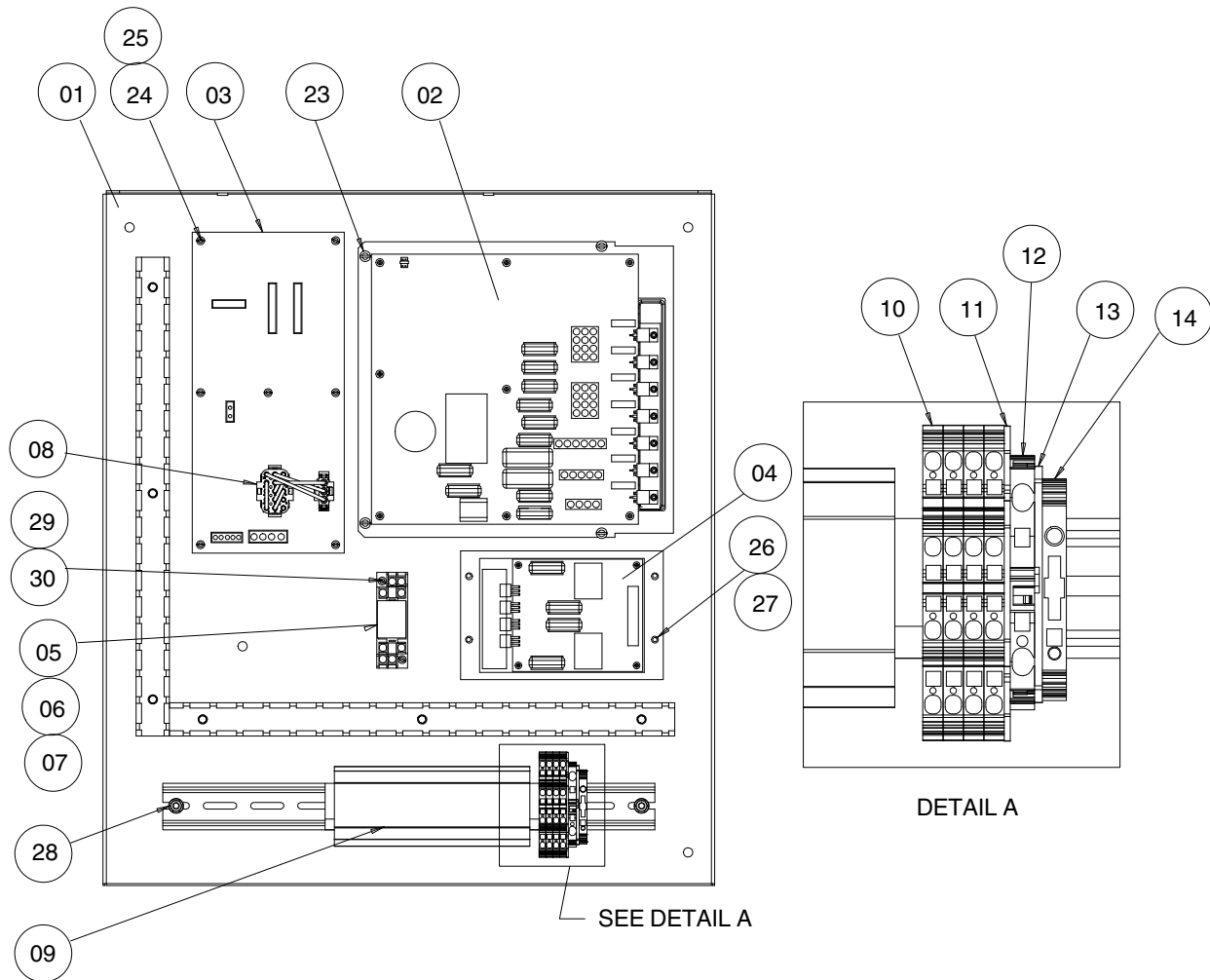

Figure 7-13 Melter right panel (400V melter shown)

Melter Right Panel Parts - 400V (contd)

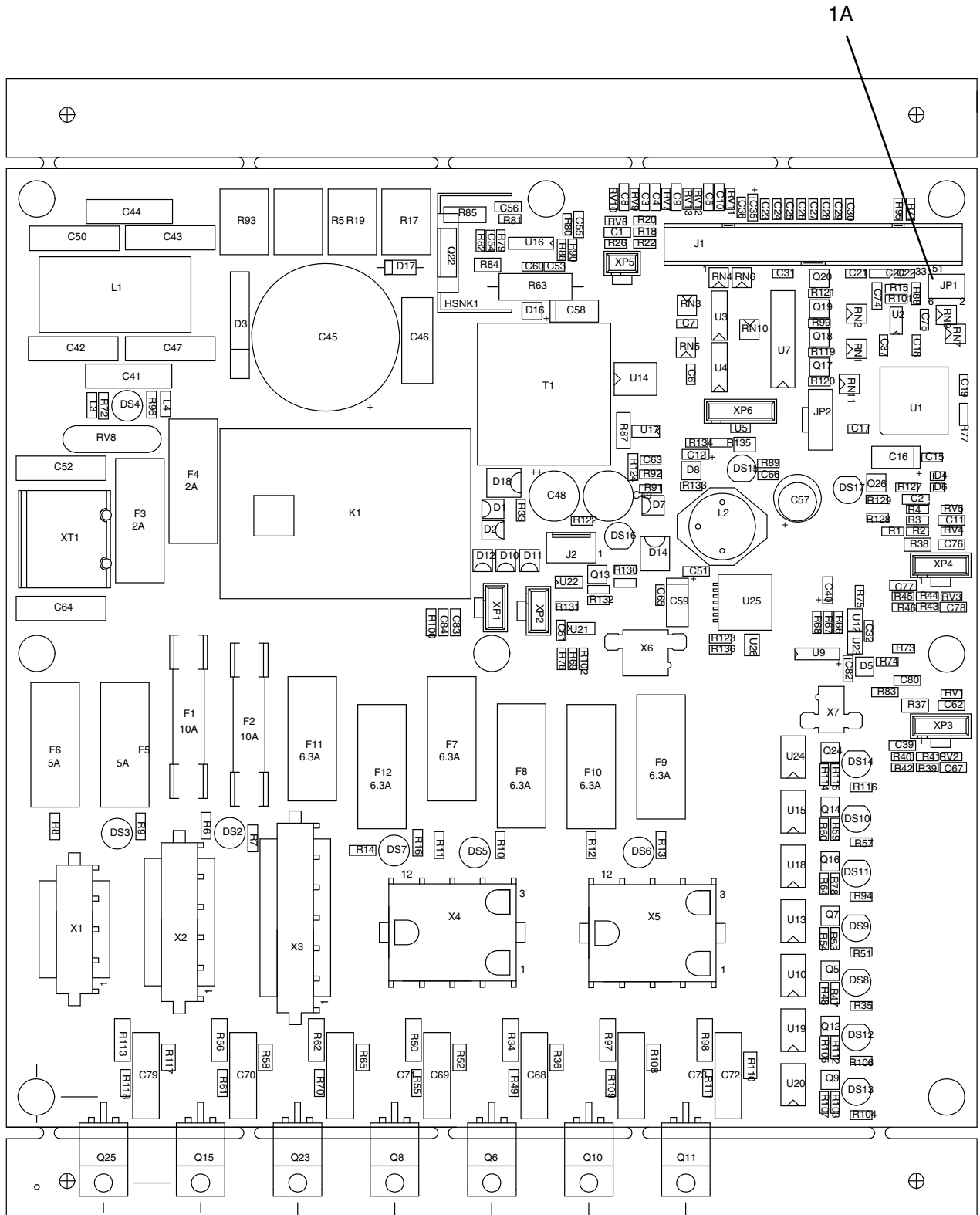

Figure 7-14 Location of the shunt on the main board



This page intentionally left blank.

# Control Panel Assembly

See Figure 7-15.

Item	Part	Description	Quantity	Note
1	7411737	KIT,SERVICE,CPU, BOARD, EZ	1	
2	7411750	PCA, MOTOR, ALTABLUE	1	
3	1025743	MEMBRANE PANEL, W/KEYPAD, FINAL, EZ	1	
4	1085183	MEMBRANE PANEL MOTOR CONTROL,STD ALTA	1	
5	1017947	SWITCH,ROCKER,SPST,250V,16A,GOLD	1	
6	1029938	CABLE ASSY, RIBBON, SERIAL PORT, 9-POS, DURA	1	
7	-----	CAP,D-SHELL CONNECTOR,9 PIN,FEM	1	
8	-----	THRDSPCRMM,MALE/FEM,SS,HEX,M3,8MMLG	7	
9	-----	WASHER,LK,M,INT,M3,STL,ZN	7	
10	-----	CONNHDWE,SCREWLOCK,#4-40,D-SUB CONNECTOR	2	

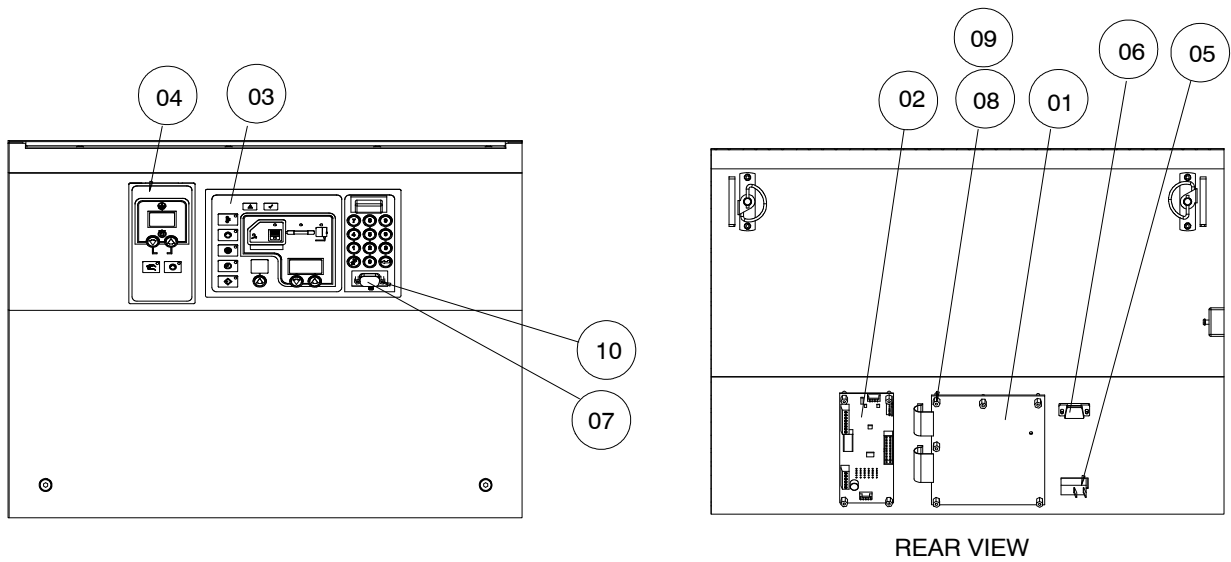

Figure 7-15 Control panel assembly parts

# Sensor Assembly

See Figure 7-16. The sensors on your melter may be one of two types:  
120-ohm nickel or 100-ohm platinum.

Item	Part	Description	Quantity	Note
01	7411749	HARNESS RTD & THERMOSTAT,EZ	1	

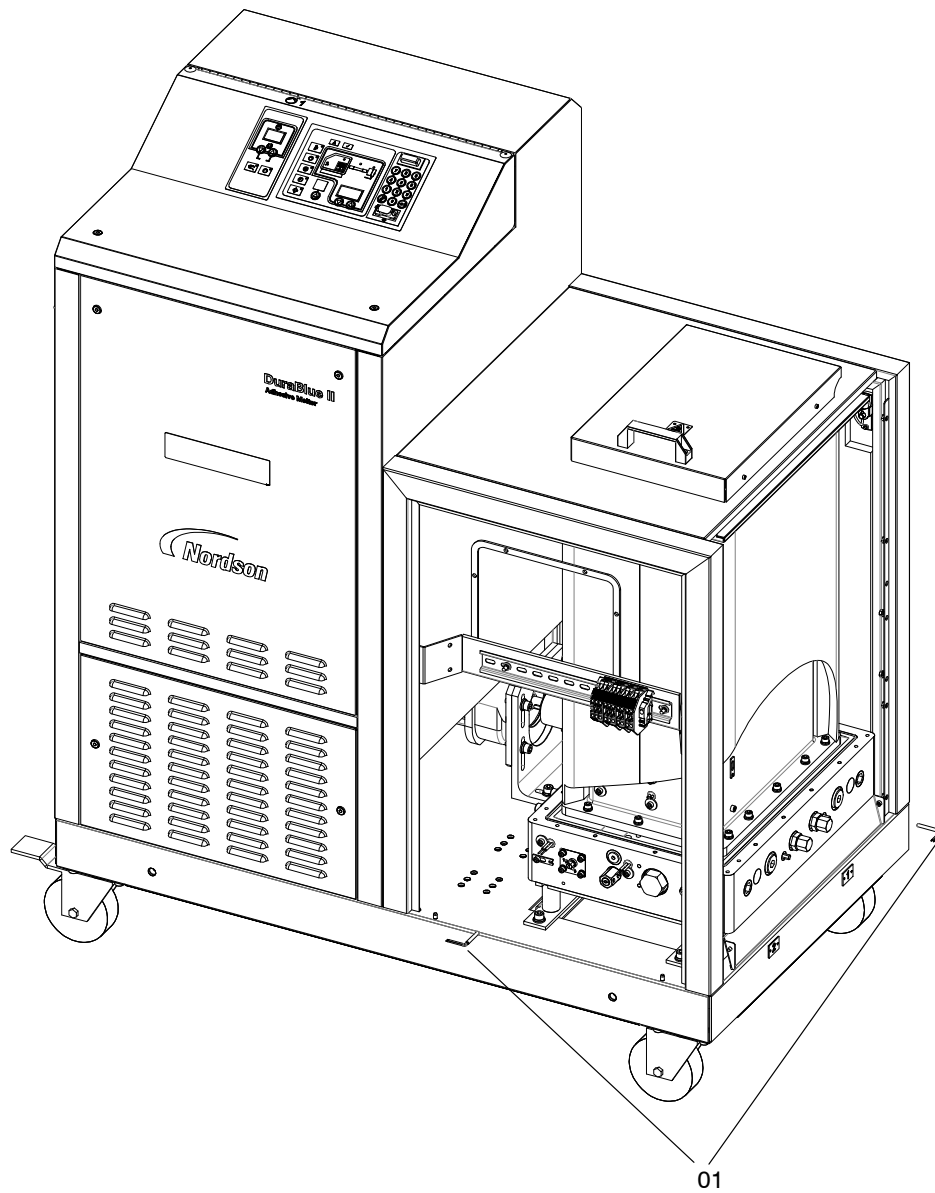

Figure 7-16 Sensor assembly parts

## Optional Fittings

See Figure 7-17. These fittings can be used at the melter end of a hose.

Hose Size	Fitting Part Number	Fitting Type	Fitting Size, Melter Side	Fitting Size, Hose Side
8-mm	7400333	Straight	M16 x 1.5	$9/16$ -18 JIC
	7400337	45-degree	M16 x 1.5	$9/16$ -18 JIC
	7400335	90-degree	M16 x 1.5	$9/16$ -18 JIC
12-mm	7401279	Straight	M16 x 1.5	$3/4$ -16 JIC
	7401278	45-degree	M16 x 1.5	$3/4$ -16 JIC
	7401277	90-degree	M16 x 1.5	$3/4$ -16 JIC
16-mm (see Note)	7400334	Straight	M22 x 1.5	$1\frac{1}{16}$ JIC
	7400338	45-degree	M22 x 1.5	$1\frac{1}{16}$ JIC
	7400336	90-degree	M22 x 1.5	$1\frac{1}{16}$ JIC

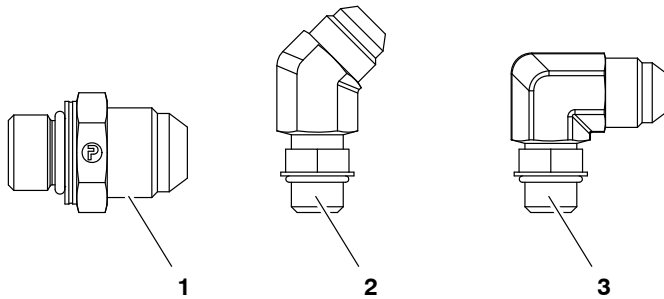

Figure 7-17 Typical non-swivel fittings

1. Straight fitting

2. 45-degree fitting

3. 90-degree fitting

## Recommended Spare Parts

Part	Description
<b>Hydraulic Parts</b>	
7402299	COUPLING, M24, DAN/NORMAL
7410580	SERVICE KIT,HEATER, 240V,800W,1/2 X 16L
7410581	SERVICE KIT,HEATER,240V,900W,1/2 X 9.0L
207932	SAFETY VALVE, 85 BAR, VB/DB
1058990	CORDSTOCK, 3 MM OD, VITON, 75D
7410545	GASKET,HOPPER,EZ,20L
7410543	GASKET,HOPPER,EZ,45L
7410582	SERVICE KIT,MOTOR,NDS-005 0.25KW
7410542	INSULATION,HOPPER,EZ,20L
7410540	INSULATION,HOPPER,EZ,45L
<b>Electrical Parts</b>	
7411700	HARNESS, HOSE/GUN HC L1,EZ
1026662	CABLE ASSY,RIBBON,34 POS,3 HEADERS
7400352	RIBBON CABLE ASSY,20POS,2 HEATERS,400V
7411739	KEYPAD,MOTOR DRIVER,EZ
7411704	HARNESS, HOSE/GUN HC H5,EZ
7411705	HARNESS, HOSE/GUN HC H6,EZ
7411731	HARNESS, HOSE/GUN HC H5,240V,EZ
7411732	HARNESS, HOSE/GUN HC H6,240V,EZ
7411735	SERVICE KIT,MOTOR CONTROL,EZ
7411712	CIRCUIT BREAKER,32A 1-POLE
7411708	BOARD,BREAKOUT,RSMA-20D0CD,TB,20POS,EZ
7411710	CIRCUIT BREAKER,50A 3-POLES
7411711	CONTACTOR,40A
7410952	RELAY,DC24V
777630	BASE, RELAY (OMRON)
207396	SOLID-STATE RELAY, 100–260 VAC, 15 A,DC TRIGGER
7400070	SOLID-STATE RELAY, 100–260 VAC, 35 A,DC TRIGGER
7411713	CIRCUIT BREAKER,16A,1-POLE
1122064	SVCE KIT,DURABLUE,MAIN,PCA
1122974	SVCE KIT, DURABLUE, EXPANSION PCA
1031175	SVCE KIT, DURABLUE, 2H TO 4H CONVERSION
7400010	CLIP,RELAY
227569	JUMPER3/N/PE,AC 400-230V

This page intentionally left blank.

## Section 8

# Technical Data

### General Data

<b>Storage temperature</b>	- 45° C to + 75° C - 49° F to + 167° F
<b>Type of heating</b>	Cartridge-type resistance heating elements
<b>Temperature sensor — Measuring precision</b>	Ni120 ± 1 °C
<b>Material pressure</b>	5 to 85 bar      0.5 to 8.5 MPa      72.5 to 1233 psi
<b>Melting capacity</b>	1 tank-full per hour
<b>Degree of protection</b>	IP 33
<b>Noise emission</b>	1 motor: 60 dBA 2 motors: 66 dBA
<b>Motor type</b>	3 ph AC motor
<b>Gear box type</b>	Helical gear
<b>Motor/pump speeds</b>	94 rpm
<b>Heatup time</b>	<45 min

### Temperatures

<b>Min. ambient temperature</b>	– 5 °C	23 °F
<b>Max. ambient temperature</b>	40 °C	104 °F
<b>Humidity</b>	10 to 95 %, not condensing	
<b>Min. operating temperature (setpoint)</b>	40 °C	100 °F
<b>Max. operating temperatures</b>	230 °C	450 °F
<b>Overtemperature shutdown by thermostat</b>	260 °C	500 °F

## Electrical Data



**WARNING!** The unit is designed for only one operating voltage. Operate only at the operating voltage shown on the ID plate.

<b>Available operating voltages</b>	400 V <sub>AC</sub> 3-phase with neutral (star — WYE)	
<b>Maximum melter power requirements</b>	20L	14740 W
	45L	16540 W
<b>Operating voltage frequency</b>	50/60 Hz	
<b>Fuse protection</b>	Refer to ID plate	
<b>Melter Internal Heater Power Wattage</b>	20L	45L
	Grid: 3x900 W	Grid: 5x900 W
	Manifold: 3x800 W	Manifold: 3x800 W
<b>Max. load per hose receptacle</b>	1000 W, any single hose or applicator 1200 W, any hose/applicator pair 2000 W, sum of hose/applicator pairs 1 and 2 2000 W, sum of hose/applicator pairs 3 and 4 2000 W, any single hose, or applicator 5 or 6 2000 W, hose/applicator pair 5 or 6 4000 W, sum of hose/applicator pairs 5 and 6 <b>NOTE:</b> Total external wattage must not exceed 8,000 W.	

## Mechanical Data

Item	20L	45L
Weight	205 kg (451 lb)	240 kg (529 lb)
Tank opening (length and width)	170 x 250 mm	170 x 250 mm
Melter Appearance (length, width and height)	1250 x 600 x 1230 mm	1250 x 600 x 1230 mm
Approximate tank volume	20 L	45 L
Number of hose connections	Single-stream manifolds: 2 connections per pump stream	



## ***Electrical Schematics***

Refer to the electrical schematics provided with the melter.

# Hydraulic Schematic

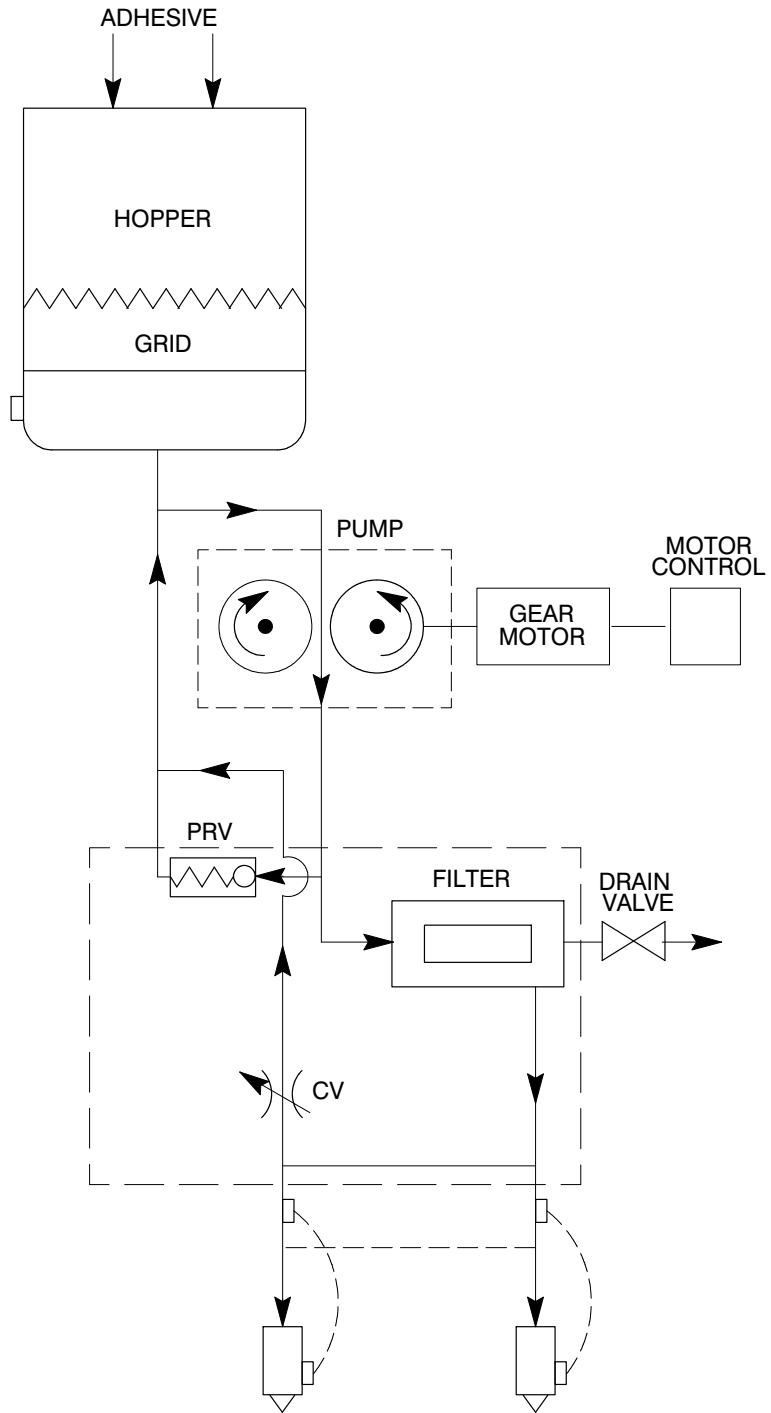

Figure 8-1 Hydraulic system schematic

## *Appendix A*

# Calculating Melter Power Requirements

Before locating the melter on the production floor or attaching hoses and guns to the melter, you must calculate the electrical power required by the hoses and guns and confirm that the required power does not exceed maximum allowable wattages. Properly calculating melter power requirements will prevent damage to the melter and identify the maximum allowable distance between the melter and the point at which the hot melt is dispensed.

The following three maximum wattages must be considered when calculating melter power requirements.

- **Single-component maximum** — The wattage of any single hose or gun
- **Hose/gun pair maximum** — The combined wattage of any hose and gun (hose/gun pair)
- **Two hose/gun pair maximum** — The combined wattage of hose/gun pairs 1 and 2 or hose/guns pairs 3 and 4

If your Nordson representative has already calculated the hose/gun power requirements and confirmed that the maximum allowable wattages will not be exceeded, then no further calculation is necessary. However, you should re-evaluate the hose and gun power requirements before you:

- add a new hose or gun to the melter that was not factored into the original wattage evaluation
- replace an existing hose with a longer hose or an existing gun with a larger gun

## Evaluate Hose/Applicator Power Requirements

1. Identify all hose/applicator pairs based on the hose/applicator receptacle to which they are connected.
2. Examine the identification tag or plate on each hose and applicator and record the wattage of each in Column A of Table A-1. Enter a zero for any hose or applicator that is not installed.
3. Add the wattages of each hose/applicator pair and place the sum in Column B of Table A-1.
4. Add the wattages of the hose/applicator pairs and place the sum in Column C of Table A-1.
5. Compare each of the wattages tabulated in Columns A, B, and C of Table A-1 with the associated maximum allowable wattages in Table A-2, as appropriate.
6. Do *one* of the following:
  - If each of the wattages calculated in step 5 *do not* exceed the associated maximum allowable wattages listed in Table A-2, then the power required by the hoses and applicators is within acceptable limits.
  - If any of the wattages calculated in step 5 *does* exceed an associated maximum allowable wattage listed in Table A-2, then the configuration or position of the hose/applicator pairs must be rearranged, shorter hoses must be used, or lower power applicators must be used in order to reduce the power requirement.

Table A-1 Hose/Applicator Wattages

Component Number	Type/Size	A	B	C
		Component Wattage	Hose/Applicator Pair Wattage	Two Hose/Applicator Pair Wattage
Hose 1				
Applicator 1				
Hose 2				
Applicator 2				
Hose 3				
Applicator 3				
Hose 4				
Applicator 4				
Hose 5				
Applicator 5				
Hose 6				
Applicator 6				

Table A-2 Maximum Allowable Hose/Applicator Wattages

Column in Table A-1	Component	Maximum Wattage
A	Any single hose or applicator	1000 W
B	Any hose/applicator pair	1200 W
C	Sum of hose/applicator pairs 1 and 2	2000 W
	Sum of hose/applicator pairs 3 and 4	2000 W
D	Any single hose, or applicator 5 or 6	2000 W
E	Hose/applicator pair 5 or 6	2000 W
F	Sum of hose/applicator pairs 5 and 6	4000 W
<b>NOTE:</b> Total external wattage must not exceed 8,000 W.		



## Appendix B

# Operating Parameters

Operating parameters are organized in this appendix according to the logical groups listed in Table B-1. For information about selecting and editing operating parameters, refer to Section 3, *Installation, Setting Up the Melter*.

**NOTE:** Parameter numbers that are reserved or that are not used do not appear in this appendix.

Table B-1 Parameter Groups

Group	Parameters	Description
Standard	0 to 13	Frequently used parameters
Temperature Control	20 to 29	Control heater function
Input Setup	30 to 33	Configure the inputs
Output Setup	40 to 42	Configure the outputs
Seven-day Clock	50 to 77	Configure the clock feature
PID Selection	80 to 91	Change preset PID settings

# Standard

---

## 0 Enter Password

<b>Description:</b>	A user-defined password that prevents unauthorized changes to set-point temperatures and operating parameters.
<b>Value:</b>	0 to 9999
<b>Resolution:</b>	1
<b>Default Value:</b>	4000
<b>Format:</b>	—
<b>Use:</b>	This parameter only appears if a password is created using parameter 11 and then enabled using parameter 10. <b>NOTE:</b> The melter remains in the password-protected mode for two minutes after the last key press. After exiting the setup mode, attempting to re-enter the setup mode, even before two minutes has elapsed, will require you to re-enter the password.

---

## 1 Total Hours with Heaters On (Noneditable)

<b>Description:</b>	A non editable value that indicates the total number of hours that the heaters have been on.
<b>Value:</b>	9999 (control panel) and 999,999 on the web browser
<b>Resolution:</b>	1 hour
<b>Default Value:</b>	0
<b>Format:</b>	—
<b>Use:</b>	The display registers up to 9999 hours and then rolls over to 0000.

---

## 2 Fault Log (Noneditable)

<b>Description:</b>	Stores a record of the last ten faults.
<b>Value:</b>	—
<b>Resolution:</b>	—
<b>Default Value:</b>	_-F0 (unused log entry)
<b>Format:</b>	F1, F2, F3, and F4
<b>Use:</b>	Use the right-display scroll keys to review the log entries for the last ten faults. Empty log entries are indicated by “_-F0.” Refer to <i>Monitor the Melter</i> in Section 4, <i>Operation</i> .



**3 Change History Log****(Noneditable)**

<b>Description:</b>	Records the last ten changes made to either the set-point temperatures or the operating parameters.
<b>Value:</b>	—
<b>Resolution:</b>	—
<b>Default Value:</b>	P_ (unused log entry)
<b>Format:</b>	Refer to Section 3, <i>Installation. Review Parameter and Set-point Temperature Changes.</i>
<b>Use:</b>	Use the right-display key to review the log entries for the last ten changes that were made to the operating parameters or the set-point temperatures. Empty log entries are indicated by “P_.”

**4 Ready Delay Time**

<b>Description:</b>	The amount of time that will elapse after all of the components have reached their set-point temperature before the ready LED will turn on. The ready delay time only functions when the temperature of the tank, at the time the melter is turned on, is more than 27 °C (50 °F) from its set-point temperature. The ready delay time begins when all components are within 3 °C (5 °F) of their respective set-point temperature.
<b>Value:</b>	0 to 60 minutes
<b>Resolution:</b>	1 minute
<b>Default Value:</b>	0 minutes
<b>Format:</b>	—
<b>Use:</b>	The ready delay allows the contents of the tank an additional amount of time to heat before pump turns on. <b>NOTE:</b> The time remaining on the ready delay is indicated in minutes in the right display at the end of every automatic scan cycle. When the delay time reaches 1 minute, the time remaining appears in seconds.

**5 Service Interval Time**

<b>Description:</b>	The number of heater-on hours that must elapse before the service LED turns on.
<b>Value:</b>	0 hours (disabled) to 8736 (one year)
<b>Resolution:</b>	1 hour
<b>Default Value:</b>	500 hours
<b>Format:</b>	—
<b>Use:</b>	Set the service interval time to signal a user-defined service check or maintenance event, such as changing the filter. The service LED will turn on after the pre-set time elapses. With the melter in the scan mode, press the <b>Clear/Reset</b> key to turn off the service LED and reset the time.

## Standard *(contd)*

---

### 6 Service LED Heater Hours

<b>Description:</b>	A timer indicates how many more hours the heaters need to remain on before the service LED illuminates (service required).
<b>Value:</b>	0 hours (disabled) to 9999
<b>Resolution:</b>	1 hour
<b>Default Value:</b>	0
<b>Format:</b>	—
<b>Use:</b>	The service interval time (parameter 5) must be enabled before this parameter will work.
	<b>Note:</b> Heater hours accumulate whenever the heaters LED is illuminated.

### 7 Motor Off Delay

<b>Description:</b>	Not being used, only displayed.
---------------------	---------------------------------

### 10 Enable or Disable the Melter Password

<b>Description:</b>	Activates or deactivates the melter password. When password protection is activated, component set-point temperatures or melter operating parameters cannot be changed until a valid password is entered using parameter 0.
<b>Value:</b>	0 (disabled) 1 (enabled)
<b>Resolution:</b>	—
<b>Default Value:</b>	0
<b>Format:</b>	—
<b>Use:</b>	A password must first be created using parameter 11 before it can be enabled or disabled using parameter 10.

### 11 Create Password

<b>Description:</b>	A user-defined password that prevents unauthorized changes to operating parameters or set-point temperatures.
<b>Value:</b>	0 to 9999
<b>Resolution:</b>	1
<b>Default Value:</b>	5000
<b>Format:</b>	—
<b>Use:</b>	Refer to Section 4, <i>Operation, Enter Password</i> .
	<b>NOTE:</b> When the password is created and enabled, parameter 10 will not appear again in the right display until the password is entered.

---

**20 Temperature Units**

<b>Description:</b>	Sets the units for temperature display.
<b>Value:</b>	C (degrees Celsius) or F (degrees Fahrenheit)
<b>Resolution:</b>	0 = Celsius 1 = Fahrenheit
<b>Default Value:</b>	0
<b>Format:</b>	—
<b>Use:</b>	—

---

**21 Over Temperature Delta**

<b>Description:</b>	The number of degrees that the temperature of any component can increase over its assigned set-point temperature before an over temperature fault (F3) will occur.
<b>Value:</b>	5 °C (10 °F) to 60 °C (110 °F)
<b>Resolution:</b>	1 °C 1 °F
<b>Default Value:</b>	15 °C (25 °F)
<b>Format:</b>	—
<b>Use:</b>	—

---

**22 Under Temperature Delta**

<b>Description:</b>	The number of degrees that the temperature of any component can decrease from its set-point temperature before an under temperature fault (F2) occurs.
<b>Value:</b>	5 °C (10 °F) to 60 °C (110 °F)
<b>Resolution:</b>	1 °C 1 °F
<b>Default Value:</b>	25 °C (50 °F)
<b>Format:</b>	—
<b>Use:</b>	—

## Standard *(contd)*

---

### 23 Standby Delta

**Description:** The number of degrees by which all heated components will be decreased when the melter is placed into the standby mode.

**Value:** 25°C to 190°C (50°F to 350°F)

**Resolution:** 1°C  
1°F

**Default Value:** 50 °C (100 °F)

**Format:** —

**Use:** A standby delta should be selected that results in a balance between melter energy savings during periods of inactivity, the amount of time and energy required to bring the melter back up to set-point temperature, and a temperature at which the hot melt can be held in the tank for extended periods of time without charring. Refer to Section 4, *Operation, Function Keys*.

**NOTE:** The standby delta does not affect the under temperature delta (parameter 22).

### 24 Automatic Standby Timeout

**Description:** The amount of time that must elapse after the last signal (applicator driver) is sent to input 1 before the melter will enter the standby mode. The automatic standby timeout feature saves energy by allowing the melter to automatically go into the standby mode if the melter detects that the guns are no longer firing.

**Value:** 0 to 1440 minutes (24 hours)

**Resolution:** 1 minute

**Default Value:** 0 (disabled)

**Format:** —

**Use:** 1. Change parameter 23 if required.  
2. Set the control option for parameter 30 (input 1) to option 10 (automatic standby)

**NOTE:** Only enable parameter 24 when a 24 VDC signal voltage is connected to input 1. If there is no voltage on the input contacts when the melter is ready, the melter will enter the standby mode after the automatic standby time.

### 25 Automatic Heaters Off Time

**Description:** The amount of time that must elapse after the automatic standby time elapses (parameter 24) before the heaters turn off.

**Value:** 0 to 1440 minutes (24 hours)

**Resolution:** 1 minute

**Default Value:** 0 (disabled)

**Format:** —

**Use:** Set parameter 24 (automatic standby timeout) to the desired value before setting parameter 25.

## 26 Manual Standby Time

<b>Description:</b>	The amount of time that the melter will remain in the standby mode after the standby key is pressed.
<b>Value:</b>	0 to 180 minutes
<b>Resolution:</b>	1 minute
<b>Default Value:</b>	0
<b>Format:</b>	—
<b>Use:</b>	Set the standby time when you want the operator to be able to place the melter into the standby mode for a limited period of time (break, lunch, etc.). When manual standby is enabled (value greater than 0 minutes), the standby LED blinks.  Set the standby delta (parameter 23) to the desired value before setting parameter 26.  <b>Note:</b> When a time value equal to or greater than 1 minute is entered, the standby LED will flash to indicate that the manual standby timer is counting down.

## 27 Hose Standby Delta

<b>Description:</b>	The number of degrees by which all heated hoses will be decreased when the applicator is placed into the standby mode.
<b>Value:</b>	1 °C to 190 °C (1 °F to 350 °F)
<b>Resolution:</b>	1 °C 1 °F
<b>Default Value:</b>	0
<b>Format:</b>	—
<b>Use:</b>	This parameter functions like parameter 23 except when it is set to 0, in which case it reverts to the setting for parameter 23.  <b>NOTE:</b> The standby delta does not affect the under temperature delta (parameter 22).

## 28 Applicator Standby Delta

<b>Description:</b>	The number of degrees by which all heated guns will be decreased when the applicator is placed into the standby mode.
<b>Value:</b>	1 °C to 190 °C (1 °F to 350 °F)
<b>Resolution:</b>	1 °C 1 °F
<b>Default Value:</b>	0
<b>Format:</b>	—
<b>Use:</b>	This parameter functions like parameter 23 except when it is set to 0, in which case it reverts to the setting for parameter 23.  <b>NOTE:</b> The standby delta does not affect the under temperature delta (parameter 22).

## Standard *(contd)*

---

### 29 Internal Zone Temperature Offset

<b>Description:</b>	The difference in the number of degrees by which the melter's internal zones will operate. If this parameter is used, the primary internal zone will operate at a lower temperature than the secondary internal zone as determined by the value of this parameter.
<b>Value:</b>	0 °C to -15 °C (0 °F to -30 °F)
<b>Resolution:</b>	1 °C 1 °F
<b>Default Value:</b>	0
<b>Format:</b>	—
<b>Use:</b>	Melter internal zones are designated as follows: DuraBlue D10/D16: primary=tank; secondary=pump DuraBlue D4L/D10L/D16L: primary=tank; secondary=pump AltaBlue TT: primary=tank; secondary=pump DuraBlue 25/50/100: primary=grid; secondary=reservoir AltaBlue 15/30/50/100: primary=grid; secondary=reservoir DuraBlue II Melter: primary=grid; secondary=reservoir DuraDrum: primary=platen; secondary=pump

# Input Setup

## 30 Input 1

**Description:** Control options that determine the function of input 1.

**Value:**

- 0 - Input Disabled
- 1 - Standby On/Off
- 2 - Heaters On/Off
- 3 - Motor 1 Enable/Disable
- 4 - Hose/Applicator 1 Enable/Disable
- 5 - Hose/Applicator 2 Enable/Disable
- 6 - Hose/Applicator 3 Enable/Disable
- 7 - Hose/Applicator 4 Enable/Disable
- 8 - Hose/Applicator 5 Enable/Disable
- 9 - Hose/Applicator 6 Enable/Disable
- 10 - *Automatic standby*
- 11 - Motor 2 Enable/Disable

**Resolution:** 1

**Default Value:** 10

**Format:**

**Use:** If Motor Enable/Disable (3) is selected, the motor will turn on whenever voltage is present on the input contacts. To require that the pump key be pressed (pump enabled) *and* that there be voltage on the input contacts before the motor can turn on, set the value of parameter 8, *Automatic Pump On* to 0 (disabled).

Refer to *Installing Melter Inputs* in Section 3, *Installation*, for information about setting up inputs.

**NOTE:** Only Input 1 offers control option 10.

Multiple inputs can be set to the same input value. After one or more inputs that have the same input value are energized, the input functionality will not be considered inactive (off) until all of the inputs with the same input value are de-energized (Multiple inputs set to the same input value are logical ORed.).

# Input Setup *(contd)*

## 31 Input 2

<b>Description:</b>	Control options that determine the function of input 2.
<b>Value:</b>	<ul style="list-style-type: none"> <li>0 - Input Disabled</li> <li>1 – Standby On/Off</li> <li>2 – Heaters On/Off</li> <li>3 – Motor 1 Enable/Disable</li> <li>4 – Hose/Applicator 1 Enable/Disable</li> <li>5 – Hose/Applicator 2 Enable/Disable</li> <li>6 – Hose/Applicator 3 Enable/Disable</li> <li>7 – Hose/Applicator 4 Enable/Disable</li> <li>8 – Hose/Applicator 5 Enable/Disable</li> <li>9 – Hose/Applicator 6 Enable/Disable</li> <li>11 - Motor 2 Enable/Disable</li> </ul>
<b>Resolution:</b>	1
<b>Default Value:</b>	1
<b>Format:</b>	—
<b>Use:</b>	<p>If Motor Enable/Disable (3) is selected, the motor will not turn on unless the pump is enabled <i>and</i> the correct voltage is present on the input contacts.</p> <p>Refer to <i>Installing Melter Inputs</i> in Section 3, <i>Installation</i>, for information about setting up inputs.</p> <p><b>NOTE:</b> Multiple inputs can be set to the same input value. After one or more inputs that have the same input value are energized, the input functionality will not be considered inactive (off) until all of the inputs with the same input value are de-energized (Multiple inputs set to the same input value are logical ORed.).</p>

## 32 Input 3

<b>Description:</b>	Control options that determine the function of input 3.
<b>Value:</b>	<ul style="list-style-type: none"> <li>0 - Input Disabled</li> <li>1 – Standby On/Off</li> <li>2 – Heaters On/Off</li> <li>3 – Motor 1 Enable/Disable</li> <li>4 – Hose/Applicator 1 Enable/Disable</li> <li>5 – Hose/Applicator 2 Enable/Disable</li> <li>6 – Hose/Applicator 3 Enable/Disable</li> <li>7 – Hose/Applicator 4 Enable/Disable</li> <li>8 – Hose/Applicator 5 Enable/Disable</li> <li>9 – Hose/Applicator 6 Enable/Disable</li> <li>11 - Motor 2 Enable/Disable</li> </ul>
<b>Resolution:</b>	1
<b>Default Value:</b>	2
<b>Format:</b>	—
<b>Use:</b>	<p>If Motor Enable/Disable (3) is selected, the motor will not turn on unless the pump is enabled <i>and</i> the correct voltage is present on the input contacts.</p> <p>Refer to <i>Installing Melter Inputs</i> in Section 3, <i>Installation</i>, for information about setting up inputs.</p> <p><b>NOTE:</b> Multiple inputs can be set to the same input value. After one or more inputs that have the same input value are energized, the input functionality will not be considered inactive (off) until all of the inputs with the same input value are de-energized (Multiple inputs set to the same input value are logical ORed.).</p>



**33** Input 4

<b>Description:</b>	Control options that determine the function of input 4.
<b>Value:</b>	<ul style="list-style-type: none"> <li>0 - Input Disabled</li> <li>1 - Standby On/Off</li> <li>2 - Motor 1 On/Off</li> <li>3 - Motor Enable/Disable</li> <li>4 - Hose/Applicator 1 Enable/Disable</li> <li>5 - Hose/Applicator 2 Enable/Disable</li> <li>6 - Hose/Applicator 3 Enable/Disable</li> <li>7 - Hose/Applicator 4 Enable/Disable</li> <li>8 - Hose/Applicator 5 Enable/Disable</li> <li>9 - Hose/Applicator 6 Enable/Disable</li> <li>11 - Motor 2 Enable/Disable</li> </ul>
<b>Resolution:</b>	1
<b>Default Value:</b>	4
<b>Format:</b>	—
<b>Use:</b>	<p>If Motor Enable/Disable (3) is selected, the motor will not turn on unless the pump is enabled <i>and</i> the correct voltage is present on the input contacts.</p> <p>Refer to <i>Installing Melter Inputs</i> in Section 3, <i>Installation</i>, for information about setting up inputs.</p> <p><b>NOTE:</b> Multiple inputs can be set to the same input value. After one or more inputs that have the same input value are energized, the input functionality will not be considered inactive (off) until all of the inputs with the same input value are de-energized (Multiple inputs set to the same input value are logical ORed.).</p>

**34 – 39** Optional Inputs 5, 6, 7, 8, 9, and 10

<b>Description:</b>	Control options that determine the function of the six optional inputs provided when the optional I/O expansion card is installed on the main board.
<b>Value:</b>	<ul style="list-style-type: none"> <li>0 - Input Disabled</li> <li>1 - Standby On/Off</li> <li>2 - Motor 1 On/Off</li> <li>3 - Motor Enable/Disable</li> <li>4 - Hose/Applicator 1 Enable/Disable</li> <li>5 - Hose/Applicator 2 Enable/Disable</li> <li>6 - Hose/Applicator 3 Enable/Disable</li> <li>7 - Hose/Applicator 4 Enable/Disable</li> <li>8 - Hose/Applicator 5 Enable/Disable</li> <li>9 - Hose/Applicator 6 Enable/Disable</li> <li>11 - Motor 2 Enable/Disable</li> </ul>
<b>Resolution:</b>	1
<b>Default Value:</b>	0 (Disable)
<b>Format:</b>	—
<b>Use:</b>	<p>If Motor Enable/Disable (3) is selected, the motor will not turn on unless the pump is enabled <i>and</i> the correct voltage is present on the input contacts.</p> <p>Refer to <i>Installing Melter Inputs</i> in Section 3, <i>Installation</i>, for information about setting up inputs.</p> <p><b>NOTE:</b> When more than one input is set to the same value, the controller follows the state of the active input.</p>

# Output Setup

## 40 - 42 Outputs 1, 2, and 3

<b>Description:</b>	Determines the function of the output.
<b>Value:</b>	0 = Output Disabled 1 = Ready 2 = Ready and Pump is on 3 = Fault 4 = Low level 5 = Service LED is on 6 = Alert
<b>Resolution:</b>	1
<b>Default Value:</b>	Output 1 = 1 Output 2 = 3 Output 3 = 4
<b>Format:</b>	—
<b>Use:</b>	Refer to <i>Installing Melter Outputs</i> in Section 3, <i>Installation</i> , for information on setting up outputs.  When control option 6, <i>Alert</i> is selected, the output is active whenever the melter enters the two minute fault monitoring period. If the potential fault condition clears before the end of the two minute period, the output signal ends. Refer to Section 4, <i>Operation, Monitor Melter Faults</i> , for information about fault monitoring.

## 43 - 46 Optional Outputs 4, 5, 6, and 7

<b>Description:</b>	Control options that determine the function of the four optional outputs provided when the optional I/O expansion card is installed on the main board.
<b>Value:</b>	0 = Output Disabled 1 = Ready 2 = Ready and Pump is on 3 = Fault 4 = Low level 5 = Service LED is on 6 = Alert (Potential fault)
<b>Resolution:</b>	1
<b>Default Value:</b>	1 (all optional outputs)
<b>Format:</b>	—
<b>Use:</b>	Refer to the instruction sheet provided with the optional I/O expansion card for information about wiring and setting up the optional outputs.  When control option 6, <i>Alert</i> is selected, the output is active whenever the melter enters the two minute fault monitoring period. If the potential fault condition clears before the end of the two minute period, the output signal ends. Refer to Section 4, <i>Operation, Monitor Melter Faults</i> , for information about fault monitoring.

# Seven-day Clock

Before setting up the clock, refer to *Function Keys* in Section 4, *Operation*, to familiarize yourself with the function and use of the clock feature.

If you are unfamiliar with the procedure for accessing and editing operating parameters, refer to Section 3, *Installation, Setting Up the Melter*.

## To Set the Clock

1. Use parameter 50 to select the current day of the week.
2. Use parameter 51 to set the current time of day.
3. Create schedule 1 by:
  - a.. Setting parameters 55 and 56 to the time of the day that the heaters should turn on and off.
  - b.. Setting parameters 57 and 58 to the time of the day that the melter should enter and exit the standby mode.
4. Using parameters 60 through 68, create schedules 2 and 3 by repeating step 3.
5. Use parameters 71 through 77 to assign which of the four schedules should be used on each day of the week. Up to three schedules may be assigned each day (to support three work shifts). Each of the eight control options (0 to 7) that is available in parameters 71 through 77 assigns a different combination of the three schedules. Option 0 is used hold the melter in the state dictated by the last clock transition until the next clock transition occurs.



In order for the clock to operate continuously throughout the week, a valid schedule must be assigned to every day of the week (parameters 71 through 77).

---

To prevent unintentional activation of the clock the default setting for parameters 71 through 77 is schedule 0, which has no time values assigned to it. With the default set to schedule 0, unintentionally pressing the clock key will have no affect on the melter.

## 50 Current Day

<b>Description:</b>	Used to set the current day of the week.
<b>Value:</b>	1 to 7 (1 = Monday, 2 = Tuesday, etc.)
<b>Resolution:</b>	1
<b>Default Value:</b>	—
<b>Format:</b>	—
<b>Use:</b>	Refer to Section 4, <i>Operation, Function Keys</i> , for information about the use and affects of the seven-day clock feature.

## 51 Current Time

<b>Description:</b>	Used to set the local time of the day.
<b>Value:</b>	0000 to 2359 (European time format)
<b>Resolution:</b>	1 minute
<b>Default Value:</b>	(Time set at factory)
<b>Format:</b>	<i>Hours, Hour: Minute, Minute</i>
<b>Use:</b>	This setting only needs to be made once for all daily schedules

## 55 Schedule 1 Heaters On

<b>Description:</b>	Used to set the time that the clock will turn on the heaters during schedule 1.
<b>Value:</b>	0000 to 2359, - - - -
<b>Resolution:</b>	1 minute
<b>Default Value:</b>	0600
<b>Format:</b>	<i>Hours, Hour: Minute, Minute</i>
<b>Use:</b>	Set the desired time for the heaters to turn on. To disable this parameter, set the parameter's value to "- - - -" by simultaneously pressing both of the right-display scroll keys.

## 56 Schedule 1 Heaters Off

<b>Description:</b>	Used to set the time that the clock will turn off the heaters during schedule 1.
<b>Value:</b>	0000 to 2359, - - - -
<b>Resolution:</b>	1 minute
<b>Default Value:</b>	1700
<b>Format:</b>	<i>Hours, Hour: Minute, Minute</i>
<b>Use:</b>	To disable this parameter, set the parameter's value to "- - - -" by simultaneously pressing both of the right-display scroll keys.

**57** Schedule 1 Enter Standby

<b>Description:</b>	Used to set the time that the melter will enter the standby mode during schedule 1.
<b>Value:</b>	0000 to 2359, ----
<b>Resolution:</b>	1 minute
<b>Default Value:</b>	----
<b>Format:</b>	<i>Hour, Hour: Minute, Minute</i>
<b>Use:</b>	Set the time that the melter will enter the standby mode during schedule 1. To disable this parameter, set the parameter's value to "----" by simultaneously pressing both of the right-display scroll keys. <b>Note:</b> Do not set an enter standby time that is outside of the time period defined by the schedule's heater on and off time. The melter cannot enter the standby mode when the heaters are off.

**58** Schedule 1 Exit Standby

<b>Description:</b>	Used to set the time that the melter will exit the standby mode during schedule 1.
<b>Value:</b>	0000 to 2359, ----
<b>Resolution:</b>	1 minute
<b>Default Value:</b>	----
<b>Format:</b>	<i>Hour, Hour: Minute, Minute</i>
<b>Use:</b>	Set the time that the melter will exit the standby mode during schedule 1. To disable this parameter, set the parameter's value to "----" by simultaneously pressing both of the right-display scroll keys. <b>Note:</b> Do not set an exit standby time that is outside of the time period defined by the schedule's heater on and off time. The melter cannot enter the standby mode when the heaters are off.

**60** Schedule 2 Heaters On

<b>Description:</b>	Used to set the time that the clock will turn on the heaters during schedule 2.
<b>Value:</b>	0000 to 2359, ----
<b>Resolution:</b>	1 minute
<b>Default Value:</b>	----
<b>Format:</b>	<i>Hours, Hour: Minute, Minute</i>
<b>Use:</b>	Set the desired time for the heaters to turn on. To disable this parameter, set the parameter's value to "----" by simultaneously pressing both of the right-display scroll keys.

## Seven-day Clock *(contd)*

---

### 61 Schedule 2 Heaters Off

<b>Description:</b>	Used to set the time that the clock will turn off the heaters during schedule 2.
<b>Value:</b>	0000 to 2359, - - - -
<b>Resolution:</b>	1 minute
<b>Default Value:</b>	- - - -
<b>Format:</b>	<i>Hours, Hour: Minute, Minute</i>
<b>Use:</b>	To disable this parameter, set the parameter's value to "- - - -" by simultaneously pressing both of the right-display scroll keys.

---

### 62 Schedule 2 Enter Standby

<b>Description:</b>	Used to set the time that the melter will enter the standby mode during schedule 2.
<b>Value:</b>	0000 to 2359, - - - -
<b>Resolution:</b>	1 minute
<b>Default Value:</b>	- - - -
<b>Format:</b>	<i>Hour, Hour: Minute, Minute</i>
<b>Use:</b>	Set the time that the melter will enter the standby mode during schedule 2. To disable this parameter, set the parameter's value to "- - - -" by simultaneously pressing both of the right-display scroll keys. <b>Note:</b> Do not set an enter standby time that is outside of the time period defined by the schedule's heater on and off time. The melter cannot enter the standby mode when the heaters are off.

---

### 63 Schedule 2 Exit Standby

<b>Description:</b>	Used to set the time that the melter will exit the standby mode during schedule 2.
<b>Value:</b>	0000 to 2359, - - - -
<b>Resolution:</b>	1 minute
<b>Default Value:</b>	- - - -
<b>Format:</b>	<i>Hour, Hour: Minute, Minute</i>
<b>Use:</b>	Set the time that the melter will exit the standby mode during schedule 2. To disable this parameter, set the parameter's value to "- - - -" by simultaneously pressing both of the right-display scroll keys. <b>Note:</b> Do not set an exit standby time that is outside of the time period defined by the schedule's heater on and off time. The melter cannot enter the standby mode when the heaters are off.

**65 Schedule 3 Heaters On**

<b>Description:</b>	Used to set the time that the clock will turn on the heaters during schedule 3.
<b>Value:</b>	0000 to 2359, ----
<b>Resolution:</b>	1 minute
<b>Default Value:</b>	----
<b>Format:</b>	<i>Hours, Hour: Minute, Minute</i>
<b>Use:</b>	Set the desired time for the heaters to turn on. To disable this parameter, set the parameter's value to "-- --" by simultaneously pressing both of the right-display scroll keys.

**66 Schedule 3 Heaters Off**

<b>Description:</b>	Used to set the time that the clock will turn off the heaters during schedule 3.
<b>Value:</b>	0000 to 2359, ----
<b>Resolution:</b>	1 minute
<b>Default Value:</b>	----
<b>Format:</b>	<i>Hours, Hour: Minute, Minute</i>
<b>Use:</b>	To disable this parameter, set the parameter's value to "-- --" by simultaneously pressing both of the right-display scroll keys.

**67 Schedule 3 Enter Standby**

<b>Description:</b>	Used to set the time that the melter will enter the standby mode during schedule 3.
<b>Value:</b>	0000 to 2359, ----
<b>Resolution:</b>	1 minute
<b>Default Value:</b>	----
<b>Format:</b>	<i>Hour, Hour: Minute, Minute</i>
<b>Use:</b>	Set the time that the melter will enter the standby mode during schedule 3. To disable this parameter, set the parameter's value to "-- --" by simultaneously pressing both of the right-display scroll keys. <b>Note:</b> Do not set an enter standby time that is outside of the time period defined by the schedule's heater on and off time. The melter cannot enter the standby mode when the heaters are off.

## Seven-day Clock *(contd)*

---

### 68 Schedule 3 Exit Standby

<b>Description:</b>	Used to set the time that the melter will exit the standby mode during schedule 3.
<b>Value:</b>	0000 to 2359, - - - -
<b>Resolution:</b>	1 minute
<b>Default Value:</b>	- - - -
<b>Format:</b>	<i>Hour, Hour: Minute, Minute</i>
<b>Use:</b>	Set the time that the melter will exit the standby mode during schedule 3. To disable this parameter, set the parameter's value to "- - -" by simultaneously pressing both of the right-display scroll keys. <b>Note:</b> Do not set an exit standby time that is outside of the time period defined by the schedule's heater on and off time. The melter cannot enter the standby mode when the heaters are off.

---

### 71- 77 Schedules for the Days of the Week

<b>Description:</b>	Used to select which schedule(s) should be used on a specific day of the week.
<b>Value:</b>	0 – Remain at last clock transition 1 – Use just schedule 1 2 – Use just schedule 2 3 – Use just schedule 3 4 – Use schedule 1 and 2 5 – Use schedule 2 and 3 6 – Use schedule 1 and 3 7 – Use schedule 1, 2, and 3
<b>Resolution:</b>	1
<b>Default Value:</b>	0
<b>Format:</b>	—
<b>Use:</b>	Selects the active schedule(s) for the day. <b>NOTES:</b> If the 0 schedule option is used, the heaters will not turn on again until the next scheduled heaters on time arrives.



## ***PID Selection***

**80-91**

### **PID Selection for Receptacles, Hose/Applicator 1, 2, 3 and 4**

**Description:** Used to change the preset PID selections. Use parameter 80 to select the value for hose 1, parameter 81 to select the value for applicator 1, and so on.

**Value:** 0 = Hose  
1 = Standard gun  
2 = Large gun  
3 = Air heater

**Resolution:** —

**Default Value:** 0 or 1 depending on the channel type (hose or gun)

**Format:** —

**Use:** Consult your Nordson representative before changing PID settings.

This page intentionally left blank.

## *Appendix C*

# **Melter Communications**

This appendix describes the installation and use of the Nordson Configuration Manager (NCM) communications utility. With this utility you can:

- transfer operating parameters and temperature set-points between melters
- upgrade or reload your melter's firmware

## ***Software Availability***

If you do not already have the NCM utility, you can download it from <http://emanuals.nordson.com/adhesives/software/BlueSeriesSoftware.html>.

## ***System Requirements***

The following hardware and software requirements are necessary to install and run Blue Series software:

- Any DuraBlue II, AltaBlue, ProBlue, or DuraBlue 10/16 adhesive melter
- Serial cable
- Personal Computer with:
  - CD-RW drive or 3.5-inch floppy drive
  - Available COM port
  - 640 x 480 color monitor
  - Windows 95, 98 (second edition), ME, XP, or 2000
  - Internet Explorer version 4.0 or later (IE 5.0 is recommended)
  - Administrative privileges (Windows XP, 2000, and NT)

## Installing the Software

To meet your specific installation conditions, two versions of the software are available. Refer to Table C-1 to determine which version you need.

Table C-1 Blue Series Software Versions

Version	Use When...
Single installation file: <i>BlueSeries.exe</i>	You are downloading the software from <a href="http://www.enordson.com">www.enordson.com</a> <i>and</i> the PC you are downloading onto is connected or can be connected to the melter  OR  You are downloading the software from <a href="http://www.enordson.com">www.enordson.com</a> onto a PC that can not be connected to the melter, but the PC does have a CD-RW <i>and</i> the PC that is connected to the melter does have a CD drive  OR  You have a CD with the software <i>and</i> you have a PC with a CD drive that can be connected to the melter
Self-extracting span diskette set: <i>BlueSeriesSpan.exe</i>	You are downloading the software from <a href="http://www.enordson.com">www.enordson.com</a> onto a PC that cannot be connected to the melter <i>and</i> the PC that is connected to your melter only has a 3.5-inch floppy drive

When the installation file is executed, an installation wizard will detect your operating system and start the installation routine.

**NOTE:** Installing the NCM for the first time also installs the latest version of the melter's firmware.

**To install Blue Series software**

1. Do *one* of the following:
  - **If you are installing using the single file installation**, locate and double-click on the file *BlueSeries.exe*.
  - **If you are installing from the span diskette set**, insert *Disk 1*, and then locate and double-click on the file *Setup.exe*.

The **Blue Series Software Setup** wizard appears.

2. Click **Next**, and then follow the on-screen instructions. If you are installing from the span disk set, you will be prompted to insert additional diskettes (2 through 5) as required by your operating system.

**NOTE:** When prompted to select an installation location, Nordson Corporation recommends that you select the default location offered.

3. When the installation complete message appears, click **Finished**.

## Removing the Software from Your PC

Use the *Remove* feature provided by the Blue Series InstallShield™ Wizard to remove the software from your PC. Removing Blue Series software from your PC will not remove melter settings files that you have saved using the NCM. Settings files (.ncm extension) are stored in your Windows *My Documents* folder.

**NOTE:** Windows XP, 2000, and NT users must have administrator rights in order to remove software from their PC.

### To remove Blue Series software

1. From the Windows **Start** menu, select *Settings > Control Panel*, and then double-click **Add/Remove Programs**.

The **Add/Remove Programs** dialog box appears.

2. Select *Blue Series Software* from the list, and then click **Remove**.

## Connecting the PC and the Melter

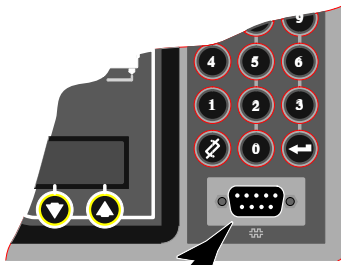

Serial port

Connect a serial cable between the PC COM port (selected during the software installation routine) and the serial port connection (COM port) on your melter's control panel.

## Using Nordson Configuration Manager



Configuration Manager desktop icon

Configuration Manager is launched from your Windows desktop using the icon shown to the left.

### Use Configuration Manager when you want to...

- copy melter settings from one melter to another melter
- create and save more than one version of melter settings
- upgrade or restore a melter's firmware

Configuration Manager communicates with your melter through a PC connected to your melter's serial port. Once connected, Configuration Manager offers the choice of saving settings, restoring settings, or upgrading the melter's firmware.

The first time you download and install Configuration Manager, the latest version of the melter's firmware is also downloaded.

## Saving and Restoring Melter Settings

Saving settings copies all current set-point and operating parameter values to your PC. Saved settings can be transferred back to the same melter or to any other compatible Blue Series adhesive melter.

### To save melter settings

1. Place the melter into the configuration mode by simultaneously pressing the **Standby** and **Setup** keys.

“**CO**nF” appears in the right display.

2. Double-click the **NCM** icon on the Windows desktop.

The **NCM** dialog box appears.

3. Click **Select Device**.

The **Select Product** dialog box appears.

4. Select your melter from the list, and then click **Ok**.

The **Select COM Port** dialog box appears.

5. Select the COM port you are using to connect to the melter, and then click **Ok**.

The PC and melter establish communications and a picture of the melter you selected appears in the device status area. The right side of the status area indicates “**CONNECTED**”.

6. Click **Save Settings**.

The **Save As** dialog box appears.

**NOTE:** The default location for saving settings files is Windows *My Documents* folder. To avoid losing saved settings files, Nordson Corporation recommends that you do not change the default save location.



7. Type a file name to identify the group of settings you are saving, and then click **Save**.

The save settings progress bar indicates the status of the save. When the save is complete, the melter automatically returns to the scan mode.

**NOTE:** If you are using the NCM to save multiple variations of melter settings, use a file naming convention that will allow you to easily associate each settings file (.ncm extension) with its related process or end-use.

8. Click **Ok** to close the NCM.

### **To restore melter settings**

1. Follow steps 1 through 5 of *To save melter settings*.

2. Click **Restore Settings**.

The **Open** dialog box appears.

3. Select the settings file (.ncm extension) that you want to restore, and then click **Open**.

The **Restore Settings** progress bar indicates the status of the restore. When the restore is complete, the melter automatically returns to the scan mode.

## **Upgrading or Restoring Melter Firmware**

Use the NCM to upgrade your melter to a newer version of firmware or reload the current version of the firmware. The version of Blue Series adhesive melter firmware that is currently available is posted on the Internet at <http://emanuals.nordson.com/adhesives/software/BlueSeriesSoftware.html>.

**NOTE:** The version of firmware that is loaded on your melter appears on the control panel when the melter is first switched on.

During the upgrade process, all current melter settings are downloaded and saved on your PC. After upgrading or restoring a melter's firmware, you can use the NCM to restore the pre-upgrade settings.

**CAUTION!** The upgrade process returns the melter's settings to factory configuration, with the exception that current heater hours data is saved. Data in both the fault log and the change log is lost after upgrading the firmware.

## Upgrading or Restoring Melter Firmware (contd)

### To upgrade or reload melter firmware

1. Connect your PC to the melter. Refer to *Connecting the PC and the Melter* earlier in this guide.
2. Place the melter into the upgrade mode by switching the melter off and then on again, and then immediately pressing and holding both the **Setup** and left display **Scroll** key.  
*UPLOAd* appears in the right display.
3. Double-click the **NCM** icon on the Windows desktop.  
The **NCM** dialog box appears.
4. Click **Select**.  
The device dialog box appears.
5. Select your melter from the list, and then click **Ok**.  
The **Select COM Port** dialog box appears.
6. Select the COM port you are using to connect to the melter, and then click **Ok**.  
The PC and melter establish communications and a picture of the melter you selected appears in the device status area. The right side of the status area indicates *Connected*.
7. Click **Upgrade**.  
The **Select Upgrade** dialog box appears.
8. In the **Available Upgrades** list, select the firmware version you want to upload to the melter, and then click **Ok**.  
The upgrade warning message appears.
9. Click **OK**.  
The **Upgrade in Progress** dialog box appears. The upgrade can take as long as 12 minutes. When the upgrade is complete, the **Success** dialog box appears and the melter restarts.

**To upgrade or reload melter firmware** (contd)

**CAUTION!** Once the upgrade progress bar appears, do not interrupt the upgrade process for any reason. Interrupting the upgrade can corrupt the melter's firmware, which will require replacement of the IC chip (IC service kit P/N 1018817).

10. Click **OK**.

The communications link between the melter and the PC is terminated.

11. Do *one* of the following:

- To restore pre-upgrade melter settings, go to *To restore pre-upgrade melter settings*.
- To close the NCM, click **Exit**.
- To restore melter settings other than the settings that were in use by the melter before the upgrade, go to *Saving and Restoring Melter Settings* earlier in this guide.

**To restore pre-upgrade melter settings**

1. Place the melter into the configuration mode by simultaneously pressing the **Standby** and **Setup** keys.

“**CO**nF” appears in the right display.

2. Click **Connect**.

The **Select COM Port** dialog box appears.

3. Select the COM port you are using to connect to the melter, and then click **Ok**.

The PC and melter establish communications and a picture of the melter you selected appears in the device status area. The right side of the status area indicates “**CONNECTED**”.

4. Click **Restore Pre-Upgrade Settings**.

The pre-upgrade settings are restored and the melter returns to the scan mode.

5. Click **Exit** to close the NCM.

# Troubleshooting

## Using Nordson Configuration Manager

Symptom/Message	Action
After selecting a device and the COM port, an <i>Access Denied</i> message appears.	PC-to-Blue communications may be running or another application may be using the COM port. Close Internet Explorer and end the communications connection (if prompted). Close all other applications.
Melter in UPLOAd mode, the update process has not been initiated, and you want to stop and exit the UPLOAd mode, but you cannot get the melter out of UPLOAd.	Cycle power to the melter at the local power disconnect switch. <b>CAUTION:</b> Ensure that the firmware update process is not running before taking power off of the melter.
UPLOAd does not appear on the melter's display when you press the Setup and left display scroll keys.	You must cycle the control switch while holding the Setup and left display scroll keys.
Attempted a firmware update, but the melter display still indicates UPLOAd. OR Attempted a firmware update, but the PC has stopped responding or was interrupted during the update process.	Using the local power disconnect switch, cycle power to the melter, and then re-attempt the update. If the update is unsuccessful or the melter will not reboot, the central processor chip may be corrupted. Replace the CPU board.



