

# ProcessMate T10 Temperature Controller

## Operating Manual



Electronic pdf files of Nordson EFD manuals are also available at [www.nordsonefd.com](http://www.nordsonefd.com)



You have selected a reliable, high-quality dispensing system from Nordson EFD, the world leader in fluid dispensing. The ProcessMate™ T10 temperature controller was designed specifically for industrial dispensing and will provide you with years of trouble-free, productive service.

This manual will help you maximize the usefulness of your ProcessMate T10 controller.

Please spend a few minutes to become familiar with the controls and features. Follow our recommended testing procedures. Review the helpful information we have included, which is based on more than 50 years of industrial dispensing experience.

Most questions you will have are answered in this manual. However, if you need assistance, please do not hesitate to contact EFD or your authorized EFD distributor. Detailed contact information is provided on the last page of this document.

## The Nordson EFD Pledge

Thank You!

You have just purchased the world's finest precision dispensing equipment.

I want you to know that all of us at Nordson EFD value your business and will do everything in our power to make you a satisfied customer.

If at any time you are not fully satisfied with our equipment or the support provided by your Nordson EFD Product Application Specialist, please contact me personally at 800.556.3484 (US), 401.431.7000 (outside US), or [Tara.Tereso@nordsonefd.com](mailto:Tara.Tereso@nordsonefd.com).

I guarantee that we will resolve any problems to your satisfaction.

Thanks again for choosing Nordson EFD.

A stylized, handwritten signature of Tara Tereso in black ink.

Tara Tereso, Vice President

# Contents

Contents .....	3
Introduction .....	4
Nordson EFD Product Safety Statement .....	5
Halogenated Hydrocarbon Solvent Hazards .....	6
High Pressure Fluids.....	6
Qualified Personnel.....	6
Intended Use .....	7
Regulations and Approvals.....	7
Personal Safety.....	7
Fire Safety.....	8
Preventive Maintenance .....	8
Important Disposable Component Safety Information.....	9
Action in the Event of a Malfunction.....	9
Disposal.....	9
Equipment-Specific Safety Information.....	10
Specifications.....	11
Operating Features.....	12
Installation .....	12
Unpack the System Components.....	12
Make the System Connections.....	13
Operation.....	14
Basic Functions .....	14
Control Panel Keys .....	14
Home Screen.....	15
Switching On the Controller.....	16
Viewing or Changing Parameters .....	16
Adjusting the Temperature Setpoint .....	17
Using the Auto-Tuning Feature.....	18
Entering an Alarm Setting .....	19
Troubleshooting .....	20
Part Numbers .....	20
ProcessMate T10 Temperature Controller .....	20
Compatible Nozzle Heaters.....	20
Technical Data.....	21

## Introduction

The ProcessMate T10 temperature controller is used to control the nozzle heater for Nordson EFD Liquidyn valves. This manual provides only the basic information needed to place the temperature controller into operation quickly. To make additional adjustments to the settings, refer to the manufacturer's operating instructions: [www.nordsonefd.com/KT4TempController](http://www.nordsonefd.com/KT4TempController)

**NOTE:** Use only the Liquidyn nozzle heaters compatible with the T10 controller. Refer to "Compatible Nozzle Heaters" on page 20.



# Nordson EFD Product Safety Statement

## WARNING

The safety message that follows has a WARNING level hazard.  
Failure to comply could result in death or serious injury.



### **ELECTRIC SHOCK**

Risk of electric shock. Disconnect power before removing covers and / or disconnect, lock out, and tag switches before servicing electrical equipment. If you receive even a slight electrical shock, shut down all equipment immediately. Do not restart the equipment until the problem has been identified and corrected.

## CAUTION

The safety messages that follow have a CAUTION level hazard.  
Failure to comply may result in minor or moderate injury.



### **READ MANUAL**

Read manual for proper use of this equipment. Follow all safety instructions. Task- and equipment-specific warnings, cautions, and instructions are included in equipment documentation where appropriate. Make sure these instructions and all other equipment documents are accessible to persons operating or servicing equipment.



### **MAXIMUM AIR PRESSURE**

Unless otherwise noted in the product manual, the maximum air input pressure is 7.0 bar (100 psi). Excessive air input pressure may damage the equipment. Air input pressure is intended to be applied through an external air pressure regulator rated for 0 to 7.0 bar (0 to 100 psi).



### **RELEASE PRESSURE**

Release hydraulic and pneumatic pressure before opening, adjusting, or servicing pressurized systems or components.



### **BURNS**

Hot surfaces! Avoid contact with the hot metal surfaces of heated components. If contact can not be avoided, wear heat-protective gloves and clothing when working around heated equipment. Failure to avoid contact with hot metal surfaces can result in personal injury.

## Nordson EFD Product Safety Statement (continued)

### Halogenated Hydrocarbon Solvent Hazards

Do not use halogenated hydrocarbon solvents in a pressurized system that contains aluminum components. Under pressure, these solvents can react with aluminum and explode, causing injury, death, or property damage. Halogenated hydrocarbon solvents contain one or more of the following elements.

Element	Symbol	Prefix
Fluorine	F	“Fluoro-”
Chlorine	Cl	“Chloro-”
Bromine	Br	“Bromo-”
Iodine	I	“Iodo-”

Check the Safety Data Sheet (SDS) or contact your material supplier for more information. If you must use halogenated hydrocarbon solvents, contact your EFD representative for compatible EFD components.

### High Pressure Fluids

High pressure fluids, unless they are safely contained, are extremely hazardous. Always release fluid pressure before adjusting or servicing high pressure equipment. A jet of high pressure fluid can cut like a knife and cause serious bodily injury, amputation, or death. Fluids penetrating the skin can also cause toxic poisoning.

#### WARNING

Any injury caused by high pressure liquid can be serious. If you are injured or even suspect an injury:

- Go to an emergency room immediately.
- Tell the doctor that you suspect an injection injury.
- Show the doctor the following note.
- Tell the doctor what kind of material you were dispensing.

#### Medical Alert – Airless Spray Wounds: Note to Physician

Injection in the skin is a serious traumatic injury. It is important to treat the injury surgically as soon as possible. Do not delay treatment to research toxicity. Toxicity is a concern with some exotic coatings injected directly into the bloodstream.

### Qualified Personnel

Equipment owners are responsible for making sure that EFD equipment is installed, operated, and serviced by qualified personnel. Qualified personnel are those employees or contractors who are trained to safely perform their assigned tasks. They are familiar with all relevant safety rules and regulations and are physically capable of performing their assigned tasks.

# Nordson EFD Product Safety Statement (continued)

## Intended Use

Use of EFD equipment in ways other than those described in the documentation supplied with the equipment may result in injury to persons or damage to property. Some examples of unintended use of equipment include:

- Using incompatible materials.
- Making unauthorized modifications.
- Removing or bypassing safety guards or interlocks.
- Using incompatible or damaged parts.
- Using unapproved auxiliary equipment.
- Operating equipment in excess of maximum ratings.
- Operating equipment in an explosive atmosphere.

## Regulations and Approvals

Make sure all equipment is rated and approved for the environment in which it is used. Any approvals obtained for Nordson EFD equipment will be voided if instructions for installation, operation, and service are not followed. If the equipment is used in a manner not specified by Nordson EFD, the protection provided by the equipment may be impaired.

## Personal Safety

To prevent injury, follow these instructions:

- Do not operate or service equipment unless you are qualified.
- Do not operate equipment unless safety guards, doors, and covers are intact and automatic interlocks are operating properly. Do not bypass or disarm any safety devices.
- Keep clear of moving equipment. Before adjusting or servicing moving equipment, shut off the power supply and wait until the equipment comes to a complete stop. Lock out power and secure the equipment to prevent unexpected movement.
- Make sure spray areas and other work areas are adequately ventilated.
- When using a syringe barrel, always keep the dispensing end of the tip pointing towards the work and away from the body or face. Store syringe barrels with the tip pointing down when they are not in use.
- Obtain and read the Safety Data Sheet (SDS) for all materials used. Follow the manufacturer's instructions for safe handling and use of materials and use recommended personal protection devices.
- Be aware of less-obvious dangers in the workplace that often cannot be completely eliminated, such as hot surfaces, sharp edges, energized electrical circuits, and moving parts that cannot be enclosed or otherwise guarded for practical reasons.
- Know where emergency stop buttons, shutoff valves, and fire extinguishers are located.
- Wear hearing protection to protect against hearing loss that can be caused by exposure to vacuum exhaust port noise over long periods of time.

# Nordson EFD Product Safety Statement (continued)

## Fire Safety

To prevent a fire or explosion, follow these instructions:

- Shut down all equipment immediately if you notice static sparking or arcing. Do not restart the equipment until the cause has been identified and corrected.
- Do not smoke, weld, grind, or use open flames where flammable materials are being used or stored.
- Do not heat materials to temperatures above those recommended by the manufacturer. Make sure heat monitoring and limiting devices are working properly.
- Provide adequate ventilation to prevent dangerous concentrations of volatile particles or vapors. Refer to local codes or the SDS for guidance.
- Do not disconnect live electrical circuits when working with flammable materials. Shut off power at a disconnect switch first to prevent sparking.
- Know where emergency stop buttons, shutoff valves, and fire extinguishers are located.

## Preventive Maintenance

As part of maintaining continuous trouble-free use of this product, Nordson EFD recommends the following simple preventive maintenance checks:

- Periodically inspect tube-to-fitting connections for proper fit. Secure as necessary.
- Check tubing for cracks and contamination. Replace tubing as necessary.
- Check all wiring connections for looseness. Tighten as necessary.
- Clean: If a front panel requires cleaning, use a clean, soft, damp rag with a mild detergent cleaner. DO NOT USE strong solvents (MEK, acetone, THF, etc.) as they will damage the front panel material.
- Maintain: Use only a clean, dry air supply to the unit. The equipment does not require any other regular maintenance.
- Test: Verify the operation of features and the performance of equipment using the appropriate sections of this manual. Return faulty or defective units to Nordson EFD for replacement.
- Use only replacement parts that are designed for use with the original equipment. Contact your Nordson EFD representative for information and advice.



# Nordson EFD Product Safety Statement (continued)

## Important Disposable Component Safety Information

All Nordson EFD disposable components, including syringe barrels, cartridges, pistons, tip caps, end caps, and dispense tips, are precision engineered for one-time use. Attempting to clean and re-use components will compromise dispensing accuracy and may increase the risk of personal injury.

Always wear appropriate protective equipment and clothing suitable for your dispensing application and adhere to the following guidelines:

- Do not heat syringe barrels or cartridges to a temperature greater than 38° C (100° F).
- Dispose of components according to local regulations after one-time use.
- Do not clean components with strong solvents (MEK, acetone, THF, etc.).
- Clean cartridge retainer systems and barrel loaders with mild detergents only.
- To prevent fluid waste, use Nordson EFD SmoothFlow™ pistons.

## Action in the Event of a Malfunction

If a system or any equipment in a system malfunctions, shut off the system immediately and perform the following steps:

1. Disconnect and lock out system electrical power. If using hydraulic and pneumatic shutoff valves, close and relieve pressure.
2. For Nordson EFD air-powered dispensers, remove the syringe barrel from the adapter assembly. For Nordson EFD electro-mechanical dispensers, slowly unscrew the barrel retainer and remove the barrel from the actuator.
3. Identify the reason for the malfunction and correct it before restarting the system.

## Disposal

Dispose of equipment and materials used in operation and servicing according to local codes.

# Nordson EFD Product Safety Statement (continued)

## Equipment-Specific Safety Information

The following safety information is specific to the ProcessMate T10 controller.

### CAUTION

Use only the Liquidyn nozzle heaters compatible with the T10 controller. Refer to "Compatible Nozzle Heaters" on page 20. When using other types of heaters, a fault-free operation cannot be guaranteed. The warranty claim expires.

#### General

- Before use, read the complete operating instructions and all safety instructions to ensure safe and correct usage.
- Observe all safety instructions.
- The pictures and illustrations used in this manual may differ from the actual product.

#### Intended Use

- The controller may only be operated indoors.
- The controller may not be operated in explosive areas or with explosive media.
- Do not expose the controller to direct heat sources.

#### Operating Conditions

- Operate heaters only within the approved temperature range. Refer to "Specifications" on page 11.
- Use only heaters that are distributed by Nordson EFD specifically for this micro-dispensing valve.
- Do not subject the valve needle to force, knocks, or impact.
- Avoid long shutdown periods with the system switched on.
- Do not operate the valve in a dry condition (without dispensing material).

#### Controller Operation

- Operate the controller only when it is in good working order and in accordance with the operating conditions specified above.
- Operate the controller only when all safety devices and safety components are installed correctly and fully functional.

#### Controller Faults

In the event of a fault in the power supply and / or damage to the electrical equipment, do the following:

1. Immediately switch OFF the controller and lock out electrical power to the controller.
2. Determine the cause of the fault condition and immediately rectify.

## Specifications

**NOTE:** Specifications and technical details are subject to engineering change without prior notification.

Item	Specification
Cabinet size	65 <sub>w</sub> x 105 <sub>H</sub> x 204 <sub>D</sub> mm (2.6 <sub>w</sub> x 4.1 <sub>H</sub> x 8.0 <sub>D</sub> " )
Weight	0.9 kg (2.0 lb)
Electrical power input	24 VDC, 3.75 Amp minimum
Electrical input connector	Lumberg KV50/6
External power adapter	Fixed-voltage power supply and power cord: 24 VDC, 3.75 Amp input; 24 VDC, 3.75 Amp, 90 W maximum output
Temperature control	0–200° C (32–392° F) <b>NOTE:</b> This is a user-programmable setting to control the temperature of the nozzle heater.
Housing	Aluminum
Ambient operating conditions	Temperature: 0–40° C (32–104° F) Humidity: 10–80% Storage temperature: 10–60° C (50–140° F)
Product classification	IP40 Protection Class III
Approvals	CE

## Operating Features



Control panel (refer to "Control Panel Keys" on page 14 for details)

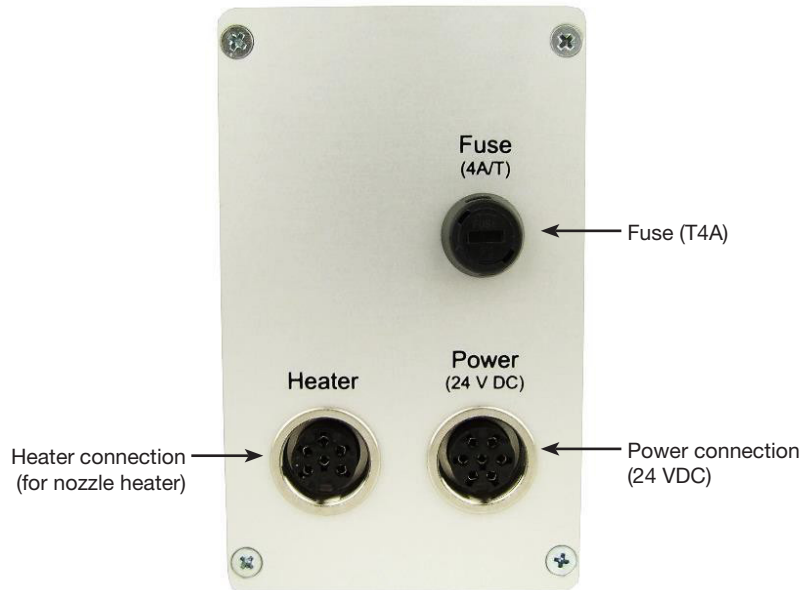

Port	Description
Heater	4-pin M5 / M8 heater cable connection
Power	7-pin power connection

## Installation

Use this section in tandem with any other system component operating manuals to install all components of the system.

### Unpack the System Components



- 1 ProcessMate T10 temperature controller
- 2 Power cord and power supply (external power adapter)

# Installation (continued)

## Make the System Connections

All connections are located on the rear panel of the controller. The step numbers below correspond to the diagram callouts.

1. Ensure that the valve is properly installed and supplied with fluid. Refer to the valve manual for valve installation instructions.
2. Connect the power cord and power supply to the POWER connection to supply the controller with 24 VDC power.
3. Connect the nozzle heater cable to the Heater connection. Refer to the valve manual for nozzle heater installation instructions.

After connecting the operating voltage, the controller will run a self-diagnosis for about 3 seconds. In the process value display the sensor identification and temperature units will be displayed. The setpoint display shows the upper measuring range limit. During the self test, all outputs and indicators are turned off. The control procedure starts only after successful diagnosis. Process (PV) and set (SV) values are displayed.

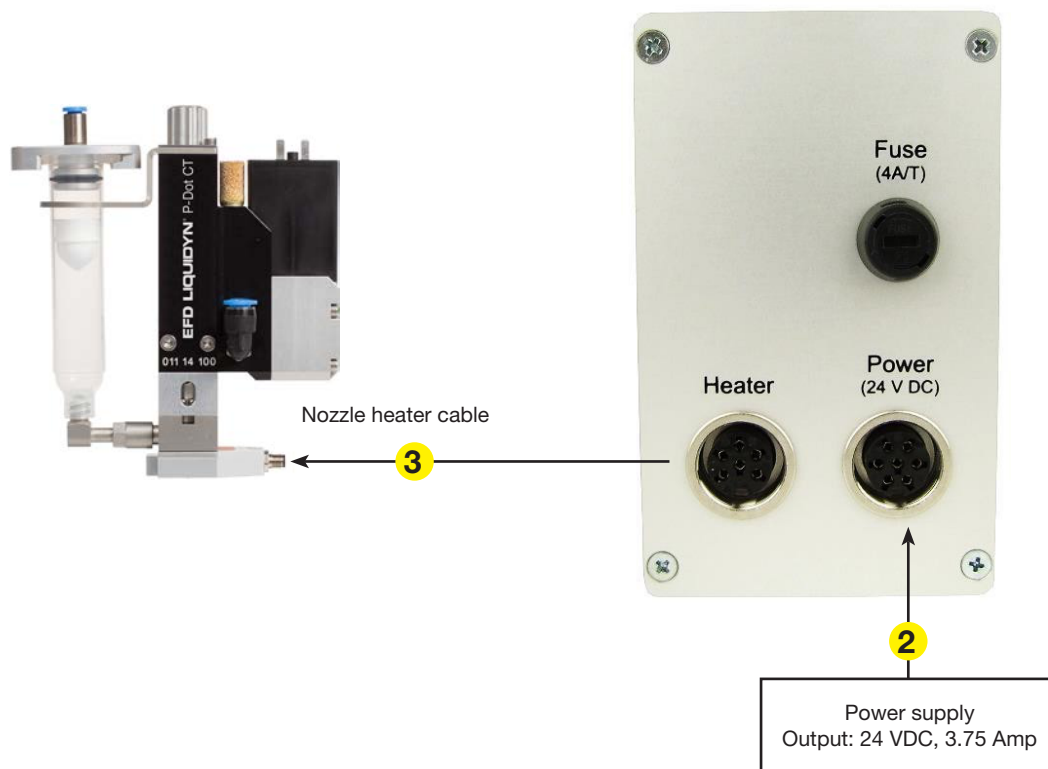





# Operation

## Basic Functions

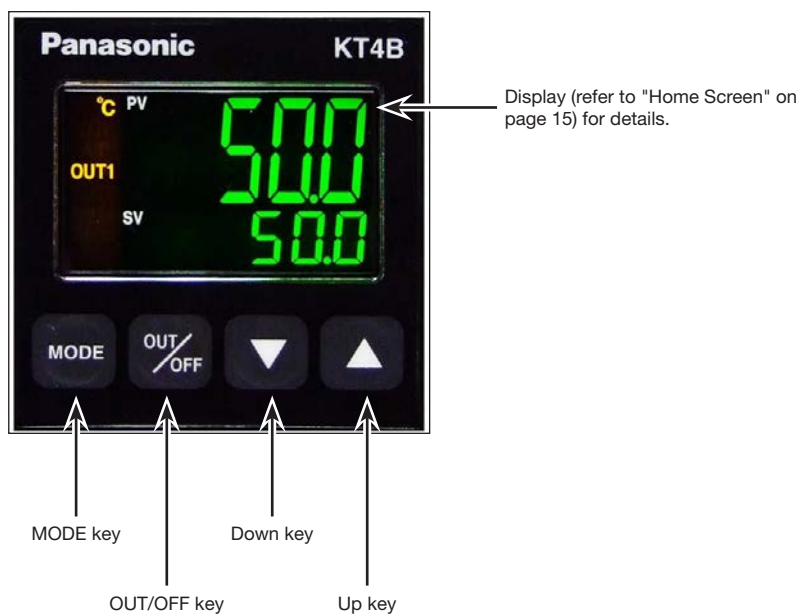
- The T10 temperature display shows the process value (actual temperature) and the temperature setpoint value. The temperature setpoint can be adjusted from 0–200° C (0–392° F).
- The temperature controller has an alarm output that activates (opens) an isolated contact in case of an adjustable control deviation, thus transmitting the alarm state to a higher-level controller.
- The controller has an automatic self-optimization (auto-tuning) function, which allows a step response to the respective outer conditions. The control behavior corresponds to that of a PID controller.

## Control Panel Keys



MODE key		Switches between parameters and saves the setting.
OUT/OFF key		Switches the temperature controller ON or OFF.
Down key		Reduces the numeric value.
Up key		Increases the numeric value.

## Operation (continued)

### Home Screen

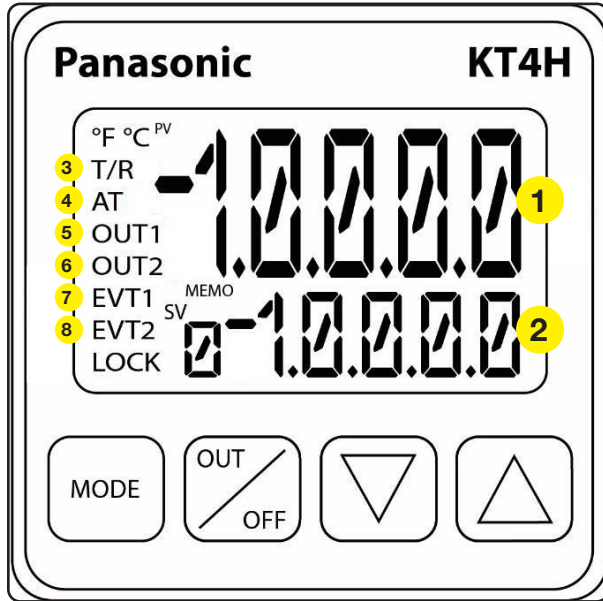

Item	Indicator	Description	Function
1	PV	Process value	Actual temperature of the nozzle heater. The process value is displayed in green.
2	SV	Set value	Setpoint temperature of the nozzle heater. The set value is displayed in green.
3	T/R	Communication	For models with the communication function, flashes yellow when data is transferred.
4	AT	Auto Tuning	Automatic adjustment of the P (proportional), I (integral), D (derivative), and ARW (anti-reset windup) values. During self-optimization or auto reset (auto tuning), this light flashes yellow.
5	OUT1	Output 1	If the OUT1 control output or the heating current output is activated, this indicator turns green. (With DC output, this indicator blinks in intervals of 0.25 s.)
6	OUT2	Output 2	If the OUT2 control output is enabled, this indicator turns yellow.
7	EVT1	Event 1	If the A1 alarm output is activated, this indicator turns red.
8	EVT2	Event 2	If the A2 alarm output or the heating current alarm output is enabled, this light turns red.

## Operation (continued)

### Switching On the Controller

To switch on the temperature controller, press and hold OUT/OFF for 3 seconds.

The Home screen appears to show the PV (actual temperature) and SV (the user-programmed temperature setpoint).

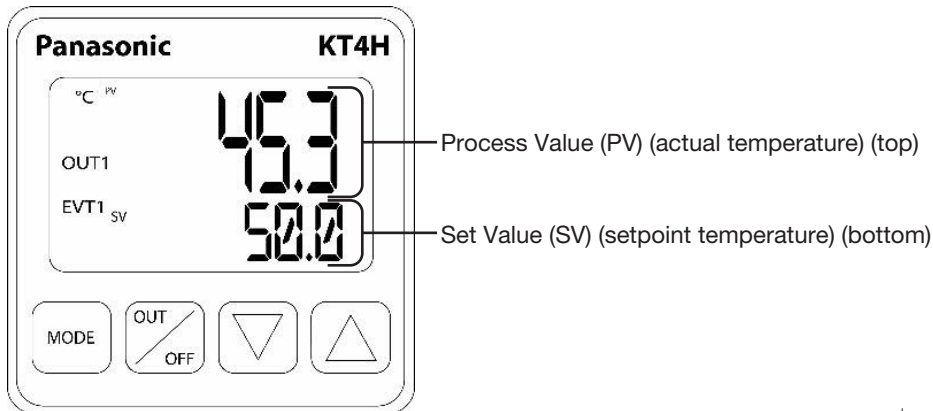

### Viewing or Changing Parameters

The temperature controller is already preset at the factory. You only need to change the temperature setpoint value. If needed, procedures for auto-tuning and setting the alarm are also provided.







**NOTE:** To make additional adjustments to the settings, refer to the manufacturer's operating instructions: [www.nordsonefd.com/KT4TempController](http://www.nordsonefd.com/KT4TempController)



# Operation (continued)

## Adjusting the Temperature Setpoint







The temperature setpoint value specifies the desired temperature of the nozzle heater.

Action / Comment	Display Reference Image
Home screen PV = Actual temperature SV = Setpoint temperature	 <p>The image shows the Panasonic KT4H controller's home screen. The display shows '°C °F' at the top left, 'PV 50.0' in the middle, and 'SV 50.0' at the bottom. Below the display are four buttons: 'MODE', 'OUT OFF', a down arrow, and an up arrow.</p>
Press MODE once.	 <p>A rectangular button labeled 'MODE'.</p>
The SV (set value) screen appears.	 <p>The image shows the controller's SV screen. The display shows '°C °F' at the top left, 'OUT1 SV' in the middle, and 'SV 60.0' at the bottom. Below the display are four buttons: 'MODE', 'OUT OFF', a down arrow, and an up arrow.</p>
Press the UP or DOWN ARROW to adjust the value.	 <p>Two square buttons: one with a downward-pointing triangle and one with an upward-pointing triangle.</p>
Press MODE to save the setting.	 <p>A rectangular button labeled 'MODE'.</p>
The display returns to the Home screen and shows the new temperature setpoint.	 <p>The image shows the controller's home screen after adjustment. The display shows '°C °F' at the top left, 'PV 56.0' in the middle, and 'SV 60.0' at the bottom. Below the display are four buttons: 'MODE', 'OUT OFF', a down arrow, and an up arrow.</p>

# Operation (continued)

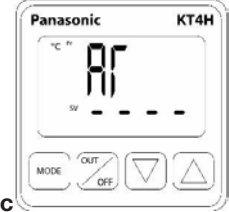
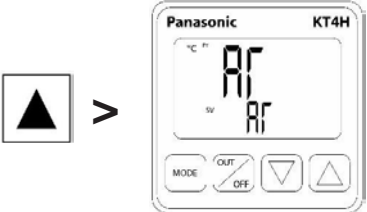
## Using the Auto-Tuning Feature





With self-optimization (auto-tuning), the P (proportional), I (integral), D (derivative), and ARW (anti-reset windup) values are automatically adjusted and readjusted based on the user-specified parameter settings. ARW prevents overload caused by the integral function at the beginning of the PID control.

Action / Comment	Display Reference Image
<p>Home screen                      PV = Actual temperature                      SV = Setpoint temperature</p>	
<p>Simultaneously press and hold the MODE and UP ARROW keys.</p>	
<p>The selection screen appears.                      SV shows four dashes (- - - -).</p>	
<p>Press the UP ARROW one (1) time so that AT appears next to SV.</p>	
<p>Press MODE to save the setting.</p>	
<p>Wait while the system auto-tunes itself. AT flashes during auto-tuning.</p>	
<p>When the display returns to the Home screen, auto-tuning is complete.</p>	

# Operation (continued)

## Entering an Alarm Setting

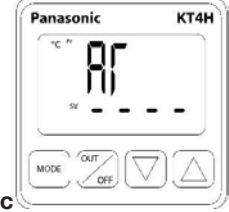
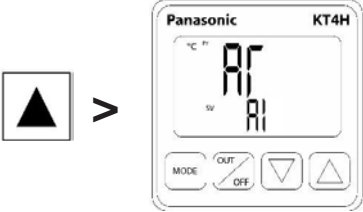
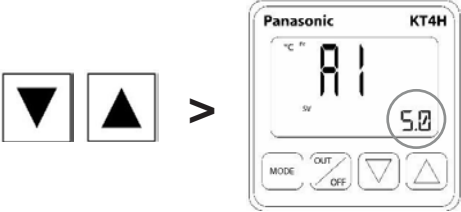
The alarm setting is a positive or negative differential that sets the value at which the alarm is triggered (the EVT1 indicator flashes).

Action / Comment	Display Reference Image
<p>Home screen                      PV = Actual temperature                      SV = Setpoint temperature</p>	
<p>Simultaneously press and hold the MODE and UP ARROW keys.</p>	
<p>The selection screen appears.                      SV shows four dashes (- - - -).</p>	
<p>Press the UP ARROW six (6) times until A1 appears next to SV.</p>	
<p>Press the UP or DOWN ARROWS until the desired alarm value appears next to SV. A long press on the up or down keys activates fast run.</p>	
<p>Press MODE to save the selection.</p>	
<p>The display returns to the Home screen.                      When an alarm is triggered, the EVT1 indicator flashes.</p>	

## Troubleshooting

This troubleshooting table covers the most commonly encountered issue. If the table does not help you correct the issue, contact Nordson EFD.

Problem	Possible Cause	Corrective Action
Heater not working	Current limit for the power supply (via external power cable) set too low	Ensure that the current limit does not impede the current.
	Cable not connected	Ensure that the heater cable is properly connected and secure.

## Part Numbers



### ProcessMate T10 Temperature Controller

Part #	Description
7825171	ProcessMate T10 temperature controller

## Compatible Nozzle Heaters

### ⚠ CAUTION

Use only the following Liquidyn nozzle heaters. When using other types of heaters, a fault-free operation cannot be guaranteed. The warranty claim expires.

Part #	Description	Material	Item
7825154	Nozzle heater kit, small, M5, straight plug	n/a	 <p>The kit includes the heater element, retaining nut, plug, O-ring, and heater key.</p>
7825155	Nozzle heater kit, small, M5, 90-degree plug	n/a	
7825149	Nozzle heater kit, standard, M5, straight plug	n/a	
7825150	Nozzle heater kit, standard, M5, 90-degree plug	n/a	
7825222	Nozzle heater kit, large, M5 <b>NOTE:</b> This larger heater element heats the material farther up into the supply tubing, allowing more fluid to be heated before it is dispensed.	n/a	
7825153	Nozzle heater element, small, M5	Aluminum	
7825148	Nozzle heater element, standard, M5	Aluminum	
7825152	Nozzle heater element, standard, M8	Aluminum	

## Technical Data

### Power Connection Pin Assignments

**NOTE:** The temperature controller is equipped with an alarm output with an adjustable control deviation that switches (opens) an isolated contact (open) and can thus transmit the alarm state to a higher-level controller.

Outputs		Inputs	
Pin	Assignment	Pin	Assignment
1	Alarm Output 1	2	24 VDC input
6	Alarm Output 2	5	GND
3	Not connected	4	Not connected
7	Not connected		

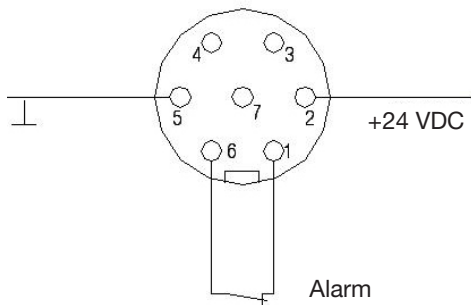

## NORDSON EFD ONE YEAR LIMITED WARRANTY

This Nordson EFD product is warranted for one year from the date of purchase to be free from defects in material and workmanship (but not against damage caused by misuse, abrasion, corrosion, negligence, accident, faulty installation, or by dispensing material incompatible with equipment) when the equipment is installed and operated in accordance with factory recommendations and instructions.

Nordson EFD will repair or replace free of charge any defective part upon authorized return of the part prepaid to our factory during the warranty period. The only exceptions are those parts which normally wear and must be replaced routinely, such as, but not limited to, valve diaphragms, seals, valve heads, needles, and nozzles.

In no event shall any liability or obligation of Nordson EFD arising from this warranty exceed the purchase price of the equipment.

Before operation, the user shall determine the suitability of this product for its intended use, and the user assumes all risk and liability whatsoever in connection therewith. Nordson EFD makes no warranty of merchantability or fitness for a particular purpose. In no event shall Nordson EFD be liable for incidental or consequential damages.

This warranty is valid only when oil-free, clean, dry, filtered air is used, where applicable.



For Nordson EFD sales and service in over 40 countries, contact Nordson EFD or go to [www.nordsonefd.com](http://www.nordsonefd.com).

**Global**

800-556-3484; +1-401-431-7000  
[info@nordsonefd.com](mailto:info@nordsonefd.com)

**Europe**

00800 7001 7001  
[infoefd.europe@nordsonefd.com](mailto:infoefd.europe@nordsonefd.com)

**Asia**

China: +86 (21) 3866 9006; [china@nordsonefd.com](mailto:china@nordsonefd.com)  
India: +91 80 4021 3600; [india@nordsonefd.com](mailto:india@nordsonefd.com)  
Japan: +81 03 5762 2760; [japan@nordsonefd.com](mailto:japan@nordsonefd.com)  
Korea: +82-31-736-8321; [korea@nordsonefd.com](mailto:korea@nordsonefd.com)  
SEAsia: +65 6796 9522; [sin-mal@nordsonefd.com](mailto:sin-mal@nordsonefd.com)

The Wave Design is a trademark of Nordson Corporation.  
©2021 Nordson Corporation 7364049 v072921